

USER'S MANUAL WLAN Adaptor

Model No. **CZ-CAPWFC2**

English

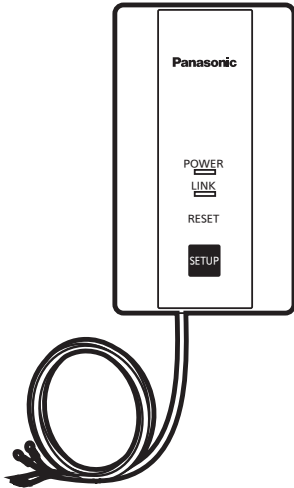

Contents

Safety Precautions	2
System Overview.....	5
Parts Identification	6
Parts.....	7
Dimensions	7
WLAN Adaptor Installation	8
Connecting Network.....	11
Use the “Panasonic Comfort Cloud”	18
WLAN Adaptor Q & A	27
Firmware Update Function	29
Copyright.....	31
Specifications	40



Thank you for purchasing this Panasonic product.
Please read these instructions carefully before using this product, and save this manual for future use.

Please Read Before Starting

These instructions are all you need for most installation sites and maintenance conditions. If you require help for a special problem, contact our sales/service outlet or your certified dealer for additional instructions.

To view the USER'S MANUAL in another language, refer to the pages for that language. Also refer to the user's manual that can be viewed on the Panasonic Comfort Cloud.

The English text are the original instructions. Other languages are translations of the original instructions.

Safety Precautions

We assume no responsibility for accidents or damages resulting from methods other than those described in the USER'S MANUAL or methods without using specified parts. Malfunctions that occur due to the unauthorised installation methods are not covered by the product warranty.

- This WLAN Adaptor must be installed in accordance with National Wiring Regulations.
- Read the installation instructions of devices to be connected as well.
- When relocating or repairing this WLAN Adaptor, provide the USER'S MANUAL to the servicing personnel.
- Please provide this USER'S MANUAL to the user after installation.
Instruct user to keep it in a safe place along with the air conditioner instruction manuals.
- The QR Code includes information required to set up the WLAN Adaptor.
There are different QR Codes for each individual product.
- The QR Codes must be left with the customer after setting up. When multiple products are to be used, the QR Codes must be kept for each individual product.
- The QR Codes include information required to register the device. The codes should therefore be stored so that they cannot be viewed by people other than those with the proper authority.



WARNING

This symbol refers to a hazard or unsafe practice which can result in severe personal injury or death.



CAUTION

This symbol refers to a hazard or unsafe practice which can result in personal injury or product or property damage.

Precautions for Installation setup and WLAN Adaptor



WARNING

- Turn off the circuit breaker of the units before installation.
- Select an installation location which is rigid and strong enough to support or hold the WLAN Adaptor, and select a location for easy maintenance.
- Use only the parts specified by Panasonic as supplied accessories.
- Ensure cables are installed properly so that external forces cannot affect them.
- Disassembly and modification of the WLAN Adaptor is not permitted under any circumstances.
- The WLAN Adaptor must be installed by the sales dealer or installer.
- When installing the WLAN Adaptor, use appropriate protective equipment and tools for safety.
- The WLAN Adaptor should be securely installed in accordance with the USER'S MANUAL.
- Electric work must be performed by authorised personnel in accordance with the local regulations and the instructions detailed in the USER'S MANUAL.
- To avoid malfunctions caused by radio wave interference, keep the WLAN Adaptor away from devices such as other wireless device, microwaves and the device that use 2.4 GHz signal. Depending on the area, the module may not be available.
- Attach the electrical cover to the indoor unit securely.
- Make sure to connect the WLAN Adaptor to the P.C. board and terminal board of the indoor unit properly.
- Do not set up in hospitals or places where electronic medical devices are located.
- If you have a cardiac pacemaker or implantable cardioverter defibrillator, please keep at least 15 cm away from the WLAN Adaptor.
- Do not use the WLAN Adaptor near to automatic control equipment (automatic door, fire alarms, etc.).
- In case of an abnormal condition (such as a burning smell), stop the indoor unit and turn the breaker OFF.
- Do not operate with wet hands.
- Do not splash water on the WLAN Adaptor or use it in the bathroom.



CAUTION

- Ground yourself to discharge static electricity before performing any wiring.
- Do not install the WLAN Adaptor in places with direct sunlight or where the ambient temperature is 55 °C or more or is 0 °C or less.
- The connecting cable must not touch piping directly.
- Do not set up where children can reach the WLAN Adaptor.
- Do not stand on an unstable surface when operating or checking the WLAN Adaptor.
- Do not use in special environments.
Use in places with much oil (including machine oil), steam, flammable or corrosive gas, voltage fluctuation, surrounding the metal body, may lead to severe decrease in functionality and damage to parts.
- Do not use the WLAN Adaptor nearby other wireless devices, microwaves, cordless phones, or facsimiles.
- This equipment is not suitable for use in locations where children are likely to be present.
- This appliance is not intended for use by persons (including children) with reduced physical, sensory or mental capabilities, or lack of experience and knowledge, unless they have been given supervision or instruction concerning use of the appliance by a person responsible for their safety. Children should be supervised to ensure that they do not play with the appliance.
<for European market only>
This appliance can be used by children aged from 8 years and above and persons with reduced physical, sensory or mental capabilities or lack of experience and knowledge if they have been given supervision or instruction concerning use of the appliance in a safe way and understand the hazards involved. Children shall not play with the appliance. Cleaning and user maintenance shall not be made by children without supervision.

NOTE

- Install the WLAN Adaptor vertically or horizontally.
- When attaching the WLAN Adaptor, be sure to use the supplied screws and confirm that the WLAN Adaptor is fixed to the surface so that there are no gaps.
- The warranty does not cover the product if it falls from an elevated location.
- The WLAN coverage must include the air conditioner installation location.
- Do not install the WLAN adaptor in locations easily accessible by third parties.
- Please write down the model information and more on the last page “Setting Information”, when you install the WLAN Adaptor.
- Requires a smartphone or tablet that is iOS/Android™ compatible.
- Please ensure that the Router supports the WPA™ / WPA2™ / WPA3™ encryption.
- To complete connection of this WLAN Adaptor to the wireless network service the Router may be required.
- The End user should read and accept the Terms of use and Privacy Notice in the contents of “Panasonic Comfort Cloud” app.
- Please avoid to set up multiple WLAN Adaptor registrations at the same time.
- There is a risk of unauthorised operation if a vulnerable password is set for the wireless router.
- Users are responsible for all costs associated with downloading and using the Comfort Cloud App and WLAN Adaptor, including without limitation all fees charged by your Device carrier and internet service provider and any other WLAN or data access charges.
- Panasonic WLAN Adaptor is designed for communication to the “Panasonic Comfort Cloud”.
- Third party WLAN interfaces cannot be connected to the “Panasonic Comfort Cloud”.
- Updates to the service may mean there are changes to the design of the “Panasonic Comfort Cloud” app screen and display.

System Overview

Indoor unit (example: 4-way cassette)

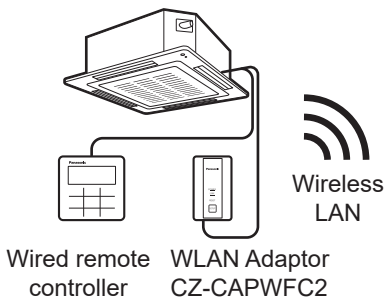

Router

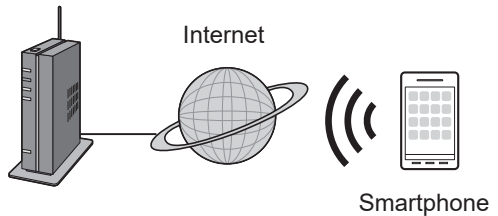

Parts Identification

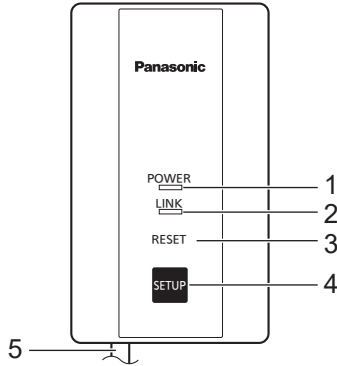

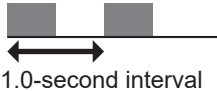
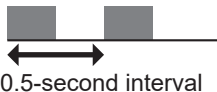

No	Item	Description
1	POWER LED (green)	<p>Indicates that the WLAN Adaptor is being supplied with power.</p> <p>On : Power being supplied Off : No power being supplied</p>
2	LINK LED (green)	<p>Indicates the communication status of the WLAN Adaptor to the router.</p> <p>Off : Not connected to router Blinks : In the process of connecting with router On : Connected to router</p> <p>The LINK LED does not light if the WLAN Adaptor cannot connect with a router.</p> <p>The following are cases with special LED indications.</p> <ul style="list-style-type: none"> When SETUP button is pressed and held The LED blinks to indicate how much time has elapsed. Blinks once after 5 seconds have elapsed Blinks twice after 10 seconds have elapsed Blinks three times after 15 seconds have elapsed Blinks four times after 20 seconds have elapsed Blinks five times after 25 seconds have elapsed Blinks six times after 30 seconds have elapsed Lights constantly after 35 seconds have elapsed When connecting with QR scan Blinks at 1.0-second intervals  When connecting with AP mode Blinks at 0.5-second intervals 

No	Item	Description
3	RESET button*1	Resetting the hardware Use to restart the WLAN Adaptor.
4	SETUP button*1	Used when making network settings. Refer to “Connecting Network” (Page 11) for details.
5	Communication lines (L=1.9 m)	These are the communication lines connecting the indoor units and the WLAN Adaptor. Refer to “WLAN Adaptor Installation” (Pages 8, 9) for details.

*1 Initialising the WLAN Adaptor

Press and hold the SETUP button (30 to 35 seconds). After this, press the RESET button within 5 seconds to initialise.

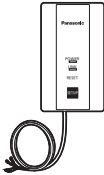
Parts

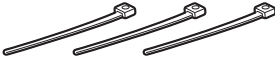
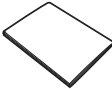
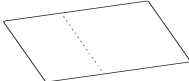
Adaptor Unit (1) (CZ-CAPWFC2) 	Screw (2)  M3.8 x 16
Clamper (3) 	USER'S MANUAL (1) 
Label (2D BARCODE for App Setting) (1) (Supplied with the USER'S MANUAL) 	

Dimensions

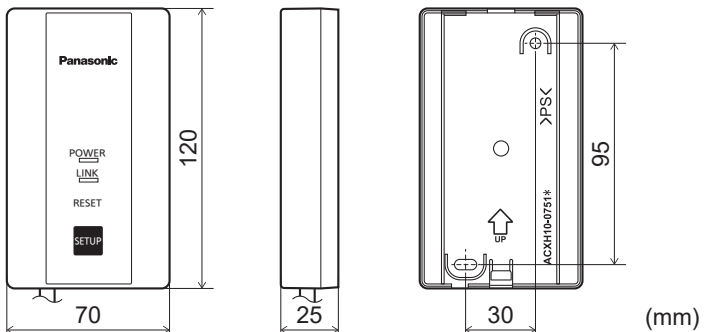

WLAN Adaptor Installation

Basic Wiring Diagram

Irrespective of the number of indoor units, the WLAN Adaptor must be used together with a remote controller.

A remote controller must be connected and it should be set as the “main unit” in the main-sub remote controller settings.

- Refer to the remote controller installation instructions for details on how to make the main-sub settings for the remote controller.
- Total length of remote controller wiring: Within 500 m
(Remote controller wiring between indoor units is within 200 m)
- Number of units that can be connected for group control
 - Indoor units : Up to 8 units
 - WLAN Adaptor : 1 unit
 - Wired remote controller : 1 unit
- The system operates irrespective of the indoor unit you choose to connect the WLAN Adaptor and remote controller to.

■ When there is 1 indoor unit

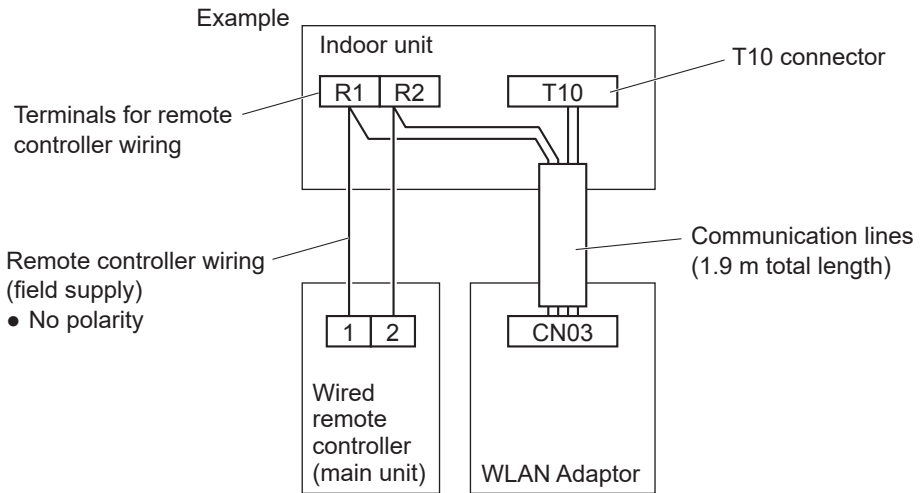

■ When there are multiple indoor units

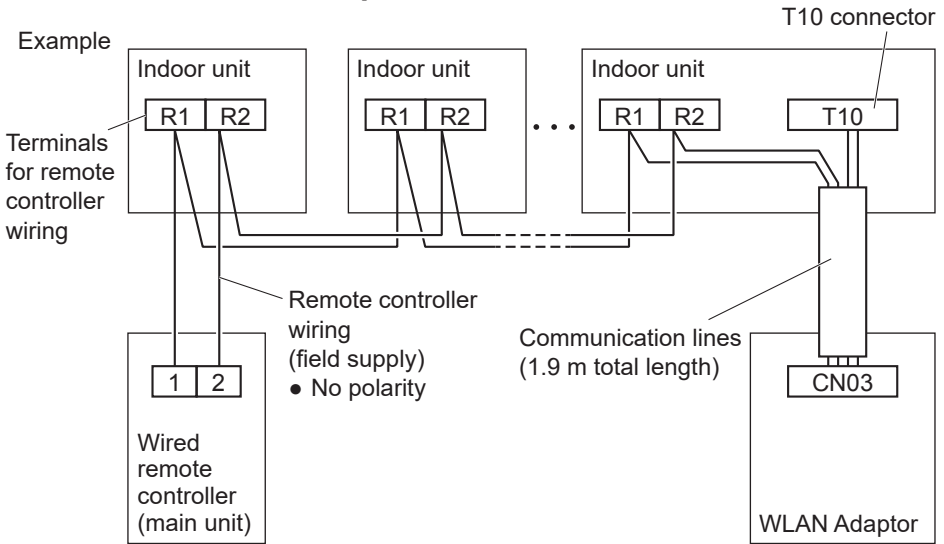

Example of standard installation

1 Connect the communication lines to the indoor unit.

Example: With a 4-way cassette indoor unit

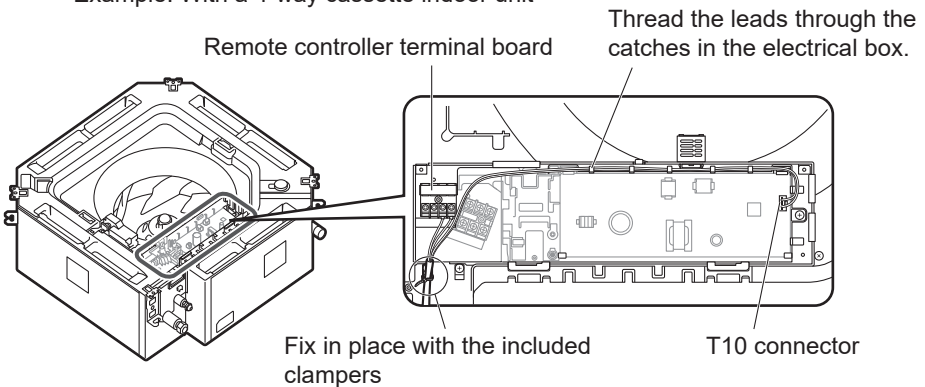

- Lead wires with crimper terminals should be connected to the remote controller terminal board.
(The lead wires with crimper terminals have no polarity.)
- Lead wires with connectors should be connected to the T10 connector.
- Fix the communication lines in place with the included clammers.
Make sure the clammers hold the parts coated in white.
- There may be left over lead wires depending on the type of indoor unit.
Tie back left over lead wires with the included clammers.

2 Remove the top case.

Use a flat head screwdriver or similar tool to push in the catch on the bottom case and remove the top case.

Take care not to break the catch when pushing with the screwdriver.

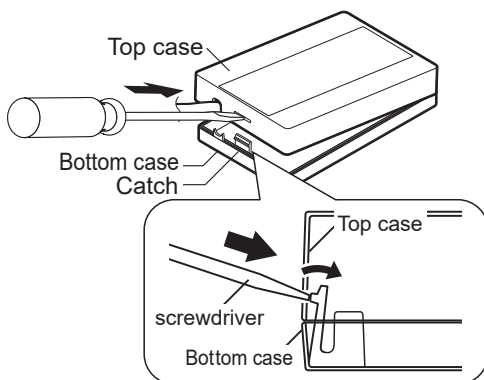

3 When attaching the bottom case to the wall (For installation on a wall surface)

Screws (supplied): 2

Attach the bottom case to the wall with the UP mark facing upwards. Please ensure screws are tightened firmly. Do not overtighten screws as this may damage the casing.

Ensure that the screws do not contact metallic parts within the wall.

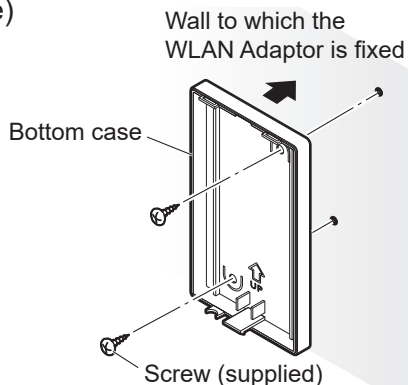

4 Attach the top case.

Fit the upper catches before fitting the lower catch.

Take care not to pinch the communication lines in the case.

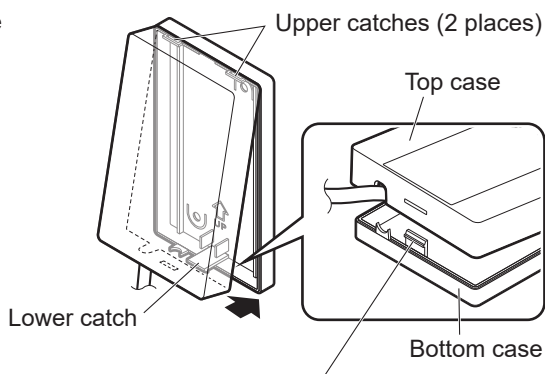

When fitting the lower catch, press down on it with a flat head screwdriver or similar tool and then fit the top case onto it. Note that applying too much pressure to the flat head screwdriver may result in damage to the catch.

Connecting Network

- Initial settings use the QR Code.
(Included with the USER'S MANUAL supplied with the product.)
The QR Code is also used when adding product users and when resetting.
- The QR Codes must be left with the customer after setting up.
- The QR Code includes information required to register the device. The code should therefore be stored so that they cannot be viewed by people other than those with the proper authority.
- When multiple products are to be used, the QR Codes must be kept for each individual product.
The serial numbers can be used to relate the products themselves and their QR Codes.

Label

(2D BARCODE for App Setting)

				SPARE	
①	SERIAL No	XXXXXXX	SERIAL No	XXXXXXX	
			Model No	CZ-CAPWFC2	
			Memo		
					③

- ① : Serial No
- ② : Model No
- ③ : Memo

(By noting the installation locations of the WLAN adaptors,
it will be easier to associate the products themselves and their QR Codes)

Adaptor Unit (CZ-CAPWFC2)

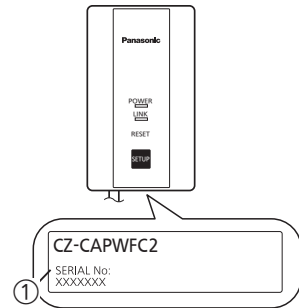

Establish network connection to the internet via Wireless mode.

1 Turn on the power supply to the indoor unit.

- The POWER LED will be lit (green).
- The LINK LED will not be lit.

<Note>

- It will not be possible to make network settings for approximately 3 minutes after turning on the power of the WLAN Adaptor due to initial settings being performed.

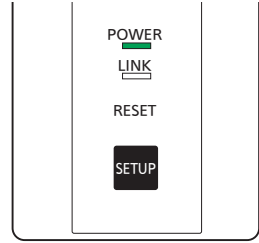

2 App Installation

For iOS user	For Android™ user
<ul style="list-style-type: none">• Open .• Search for “Panasonic Comfort Cloud” app.• Download and install.	<ul style="list-style-type: none">• Open .• Search for “Panasonic Comfort Cloud” app.• Download and install.

<Note>

- The app user interface image may change for version upgrade without notification.
- There is no charge for using this application. However, other charges may be incurred for connection and operation.

3 Starting “Panasonic Comfort Cloud”

3.1 Create New Panasonic ID

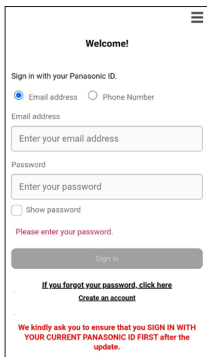

Use “Panasonic Comfort Cloud” app as an option to control the air conditioner.

- For new user, select “Create an account”.
- For registered user, login using your Panasonic ID and password.

<Note>

- It is recommended that the password is changed periodically.

3.2 App Setting

Before setting

- Confirm the wireless router is connected to the network and the router has access to the internet.
- Confirm the Wireless LAN of the smartphone is activated.
- Smartphone and air conditioner should be connected to the same wireless LAN.
- Ensure Wireless LAN is broadcasting SSID.

Add new air conditioner device

- The air conditioner needs to be registered before using “Panasonic Comfort Cloud” app.

1. At My Home screen, tap “+” to add new product.

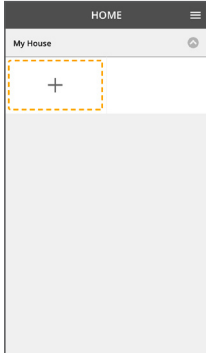

2. Select the “Commercial air conditioner” and choose the “WLAN Adaptor”.

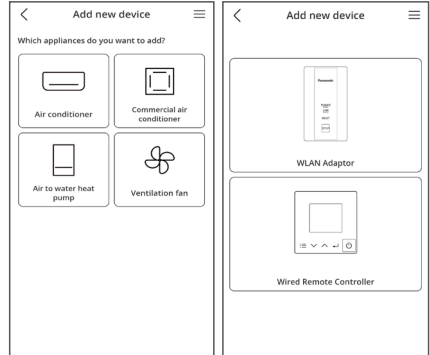

<Note>

The WLAN Adaptor is available for use with all indoor units of commercial air conditioners with names which start with “S-” except S-80/125MW1E5.

3. Tap “CZ-CAPWFC2”.

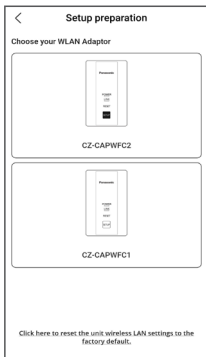

4. Select the way to setup.

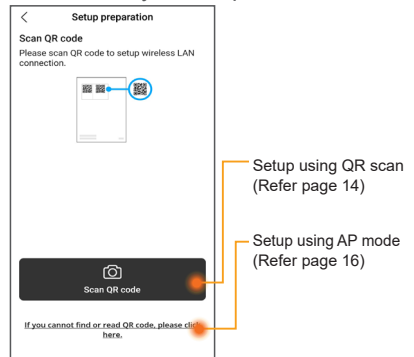

3.2 App Setting

Setup using QR scan

1. Tap “Scan QR code”.

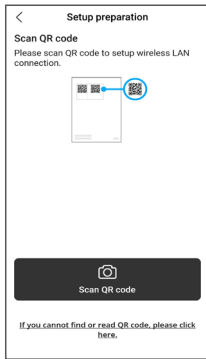

2. Scan in progress.



*1 If QR scan is failed. Proceed to “Setup using AP mode”. (Refer page 16)

3. Follow the screen instructions from the app.
Tap “Next”.

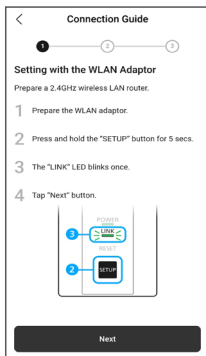

4. Connection in progress.

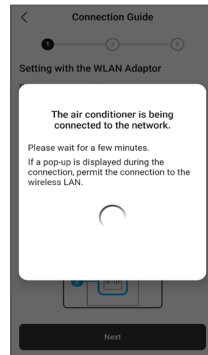

5. Select your router.

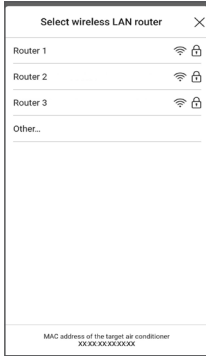

6. Input router password.

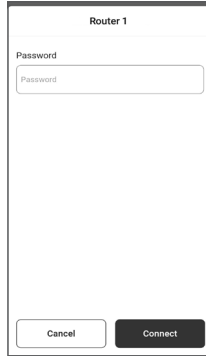

7. Connection in progress.

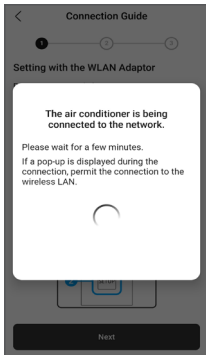

8. Set a device password.

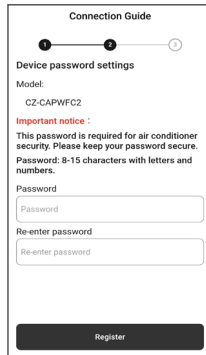

9. Enter a name for the air conditioner.

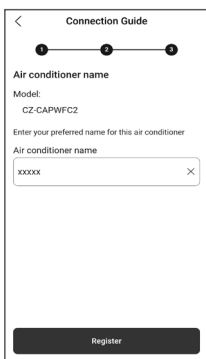

10. Registration completed.

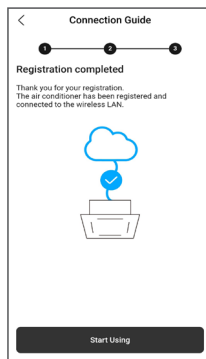

3.2 App Setting

Setup using AP mode

1. Tap “can't find QR code”.

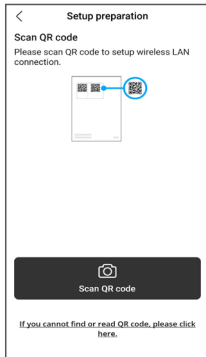

2. Follow the screen instructions from the app.
Tap “Next”.

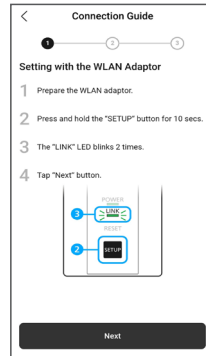

3. Tap “No”.

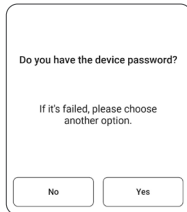

<Note>

The device password is required if the device password has already been set.

Tap “Yes” and enter the device password.

*The device password is set when first registering the product.
(Refer page 15 or 17)

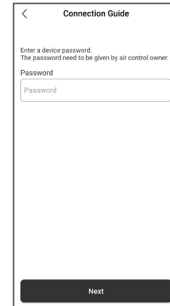

4. Tap “Connect”.

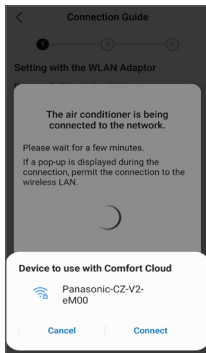

5. Select your router.

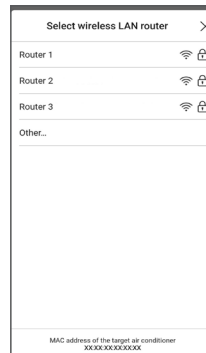

6. Input router password.

Router 1

Password

Cancel Connect

7. Connection in progress.

Connection Guide

Setting with the WLAN Adaptor

The air conditioner is being connected to the network.

Please wait for a few minutes.

If a pop-up is displayed during the connection, permit the connection to the wireless LAN.

Next

8. Set a device password.

Connection Guide

1 2 3

Device password settings

Model:
CZ-CAPWFC2

Important notice :
This password is required for air conditioner security. Please keep your password secure.
Password: 8-15 characters with letters and numbers.

Password

Re-enter password

Register

9. Enter a name for the air conditioner.

Connection Guide

1 2 3

Air conditioner name

Model:
CZ-CAPWFC2

Enter your preferred name for this air conditioner

Air conditioner name

Register

10. Registration completed.

Connection Guide

1 2 3

Registration completed

Thank you for your registration.
The air conditioner has been registered and connected to the wireless LAN.

Start Using

Use the “Panasonic Comfort Cloud”

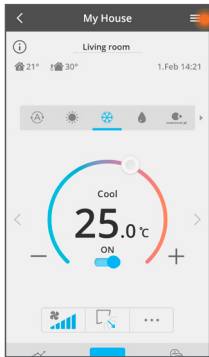

User’s manual can be found under Menu tab.

The “Panasonic Comfort Cloud” is connected to the WLAN Adaptor and ready for use.

Login

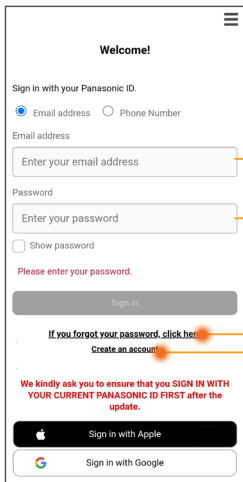

Panasonic ID

Password

Reset Panasonic ID / Password

Register for new Panasonic ID

Home Screen

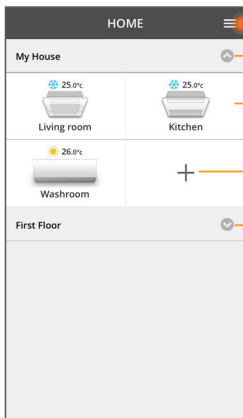

Main menu (Page 19)

1st group

Device

Add new device

2nd group

Main Menu

Options for administrator only

- User list (Page 19)
- Change device password (Page 20)
- Replace the device (Page 20)
- Change router settings (Page 20)
- List of devices (Page 21)
- List of groups (Page 22)
- Change the language of the app
- User's manual
- Terms of use
- Privacy notice
- Copyright
- Account management
- Logout from current Panasonic ID

User List

Edit the name of the user

Enable control of user

Edit / delete the user control

User's control rights

Note	Edit	Allow control	Delete
UserA		<input checked="" type="checkbox"/>	
UserB		<input checked="" type="checkbox"/>	
UserC		<input type="checkbox"/>	
UserD		<input type="checkbox"/>	
UserE			Waiting for approval

Do not approve

Only allow monitoring air conditioner status

Allow both monitoring and controlling air conditioner

Confirm

Change of Device Password

Changing device password

Make sure the device is correct and enter old password and new password. Password must be 8-15 characters with letters and numbers.

My House
Living room
Model
CZ-CAPWFC2

Old password

New password

Re-enter new password

Register

Input old password

Input new password

Retype new password

Replace the Device

Replace device

My House
Living room
CZ-CAPWFC2

Replace the WLAN adaptor

- 1 Connect the WLAN Adaptor to the server via wireless router.
- 2 Register the air conditioner to the server with smartphone.

*Kindly redo weekly timer setting after replacement of WLAN adaptor.

Start

Select "Replace device" from the menu

Tap Start

Follow the step by step instruction from app

Setup preparation

Choose your WLAN Adaptor

CZ-CAPWFC2

CZ-CAPWFC1

Click here to reset the unit wireless LAN settings to the factory default.

Change the Router Settings

Change router settings

My House
Living room
CZ-CAPWFC2

Set up the wireless network again when you have replaced the wireless router or changed the password. You will have to set up each device if two or more air conditioners are connected to the same router.

Start

Select "Change router settings" from the menu

Tap Start

Follow the step by step instruction from app

Setup preparation

Choose your WLAN Adaptor

CZ-CAPWFC2

CZ-CAPWFC1

Click here to reset the unit wireless LAN settings to the factory default.

■ Device List

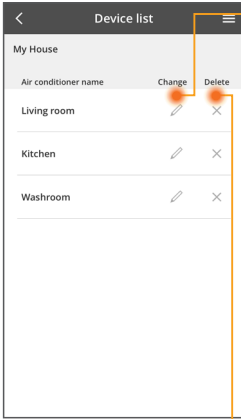

Edit the device information and setting



- Edit device name
- Change device group
- Time zone selection

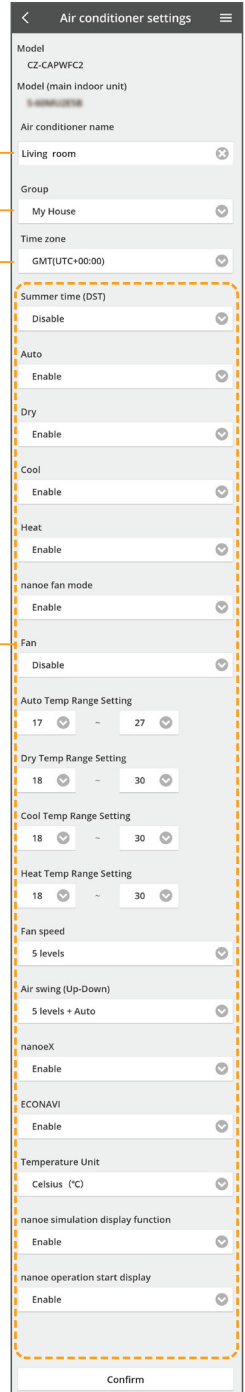

Features selection
(Features vary dependent on air conditioner model)

Delete the device

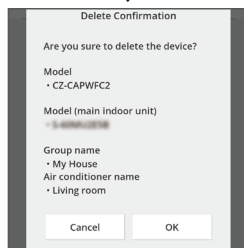

■ Group List

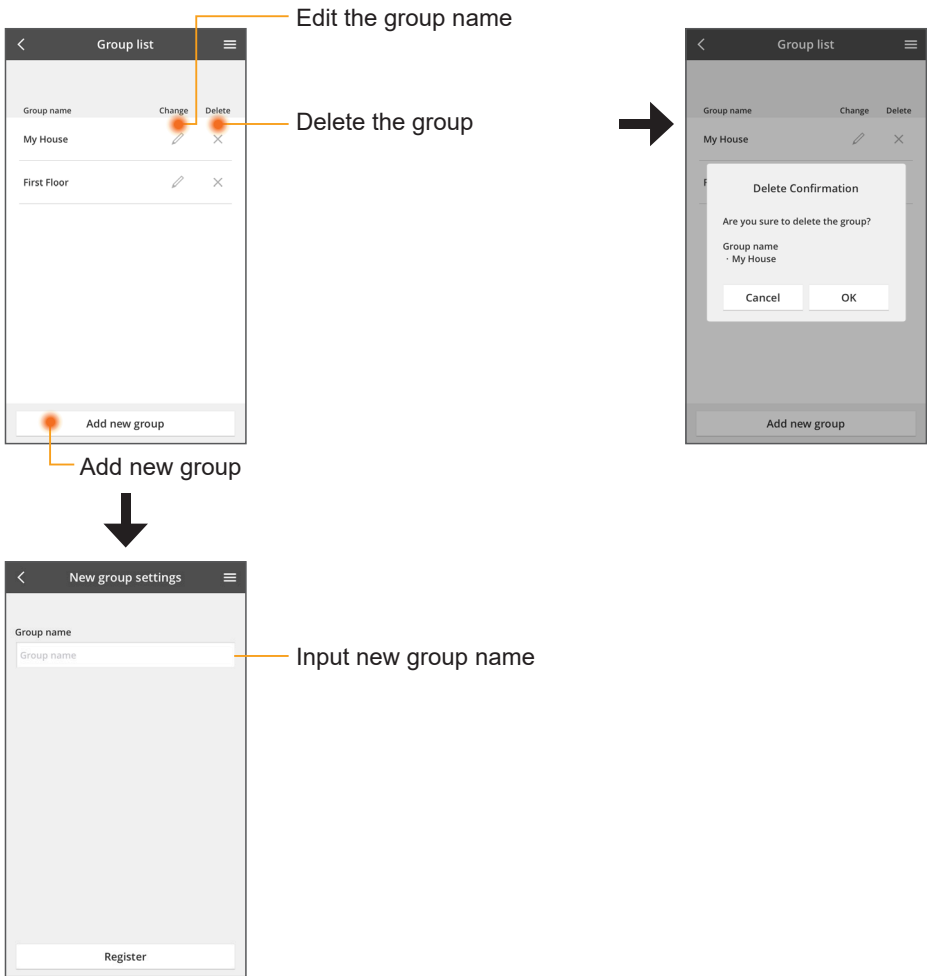

Main Device Screen

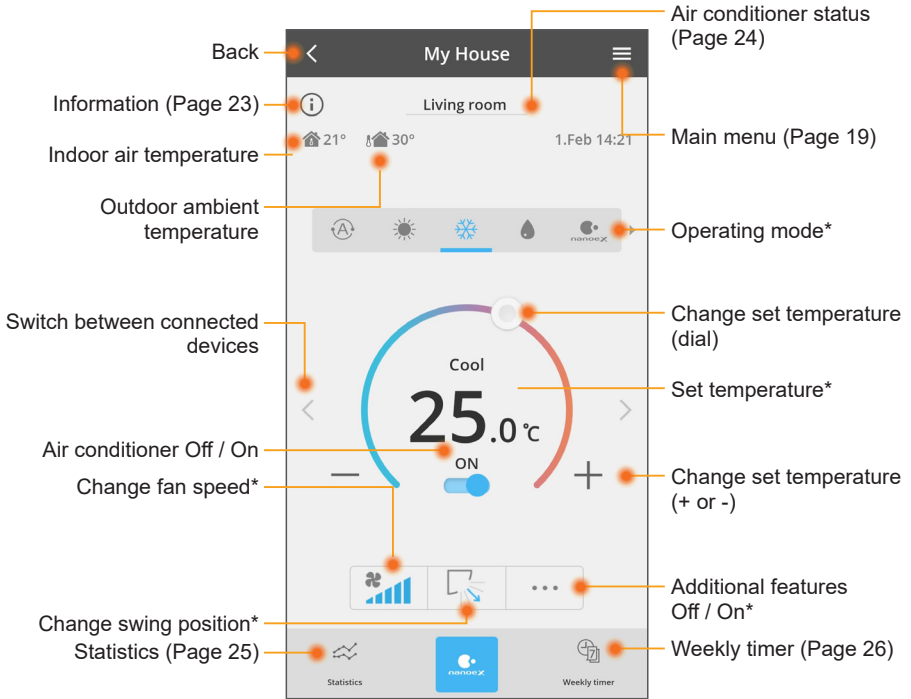

* Features vary depending on air conditioner model.

Information

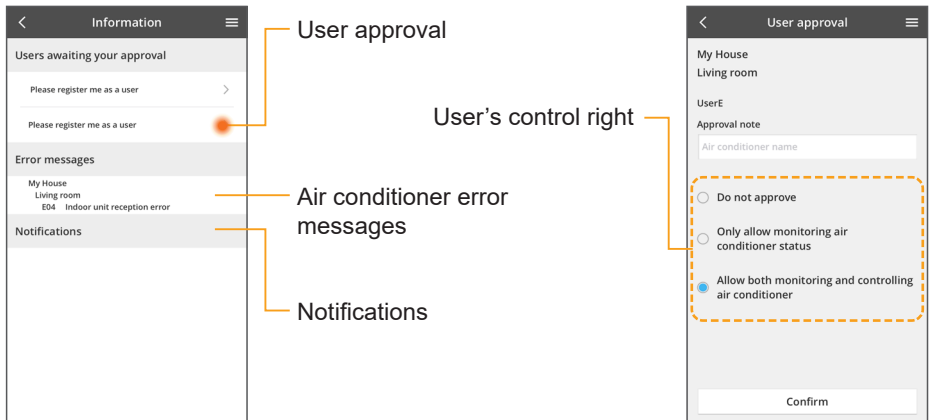

■ Air Conditioner Status

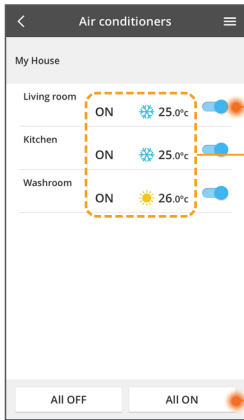

Individual off / on toggle

Air conditioners status
(Off / On, mode and set temperature)

All off / on

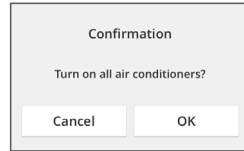

Statistics

Selection of type

Chart

Set temperature

Comparison of selected dates

Outdoor temperature

Indoor temperature

Date selection

Information for the selection date

* Estimated energy consumption may not be supported by certain models.

Comparison

Information of the selected comparison dates

- Dates are greyed out if data could not be obtained.

Date selection

Week selection

Month selection

Year selection

Weekly Timer

Edit timer

Off / On timer toggle

Add new timer

Edit timer

Copy timer

No.	Time	Settings
1.	10:00	25.0°C
2.	14:00	OFF
3.	18:00	25.0°C
4.	20:00	OFF
5.	22:00	27.0°C
6.	-	-

Add New Timer

Set time

Set conditions

Select mode

Select temperature

Off / On

- iOS is the name of the OS of Apple Inc. IOS is a trademark or registered trademark of Cisco in the US and other countries which has been licensed for use.
- Apple and the Apple logo are trademarks of Apple Inc. that are registered in the US and other countries. App Store is a service mark of Apple Inc.
- Android™, Google Play™ and Google Play™ logos are registered trademarks of Google LLC.
- “WPA™”, “WPA2™”, and “WPA3™” are the registered trademarks of the “Wi-Fi Alliance®”.
- “QR Code” is a registered trademark of DENSO WAVE INCORPORATED.
- Other names, company names, product names, etc described in this manual are trademarks or registered trademarks of each company. In the text, some ™ and ® marks are not listed.

WLAN Adaptor Q & A

Initial setting

<p>“Panasonic Comfort Cloud” app cannot be installed in smartphone.</p>	<p>Check if OS of the smartphone is compatible. The APP is not guaranteed to work with all versions of Android™ OS.</p>
<p>WLAN Adaptor and router cannot be connected.</p>	<ul style="list-style-type: none"> ● Confirm that the POWER LED is on. ● Check the following if the LINK LED does not light. ● Ensure the router’s WLAN signal reaches the WLAN Adaptor, the SSID is not hidden, the MAC address setup is enabled for the WLAN Adaptor, the router’s dual band signal is enabled for 2.4 GHz connection. ● Check the network connections. (Refer to Page 11) Refer to the smartphone and router installation manual for detail. ● Check the router settings. A router function (such as band steering for example) may be trying to connect the unit to the 5 GHz band, making it impossible to connect. Turn off the router function if this is the case.
<p>Register additional air conditioner to “Panasonic Comfort Cloud” app.</p>	<p>To set register additional units, follow the “Add new air conditioner device” procedure, as detailed at the beginning of this manual. To easily distinguish each air conditioner unit, It is recommended to uniquely name each device accordingly.</p>
<p>Register additional user to control the air conditioner.</p>	<p>Download “Panasonic Comfort Cloud” app and create new Panasonic ID. Follow initial setting. Approval from administrator (first user) is required to complete the registration. For administrator approval, select the  Menu. Choose “Owner” and select “User List” to approve additional user.</p>

Wireless Connection

Suspicious unauthorised access to the air conditioner (WLAN Adaptor).	Reset the WLAN Adaptor to manufacturing default condition by referring to "To transfer or dispose the WLAN Adaptor. When resetting the WLAN Adaptor because you have forgotten the password." method in the next section. Complete initial connection setup.
Change of smartphone's model.	Ensure the smartphone compatibility. Install "Panasonic Comfort Cloud" app and login using your Panasonic login ID and password. Complete by initial connection setup.
Change of WLAN Adaptor.	Change the WLAN Adaptor and then, use "Panasonic Comfort Cloud" app to select  Menu. Choose "Owner" and "Replace device". This shall be performed by authorised service dealer.
Replacement of router.	From "Panasonic Comfort Cloud" app, select Menu . Choose "Owner" and select "Change router settings".
Cannot find the QR Code.	The QR Code is affixed to the back cover of the manual supplied with the product. If you have lost the QR Code, use the AP mode (P.16) to setup.
QR Code cannot be read.	Wipe the QR Code clean if it is dirty. If the QR Code can still not be read, use the AP mode (P.16) to setup.
Error occurs after reading QR Code.	You may be trying to read the wrong QR Code. Confirm that the serial number on the product and the serial number on the QR Code match. If you cannot find a QR Code with a matching serial number, use the AP mode (P.16) to setup.
Do not know the password of the device.	No password is set when first registering the product. If you are asked whether you have a device password, select "No". A password has been set when registering any time after the first time, such as when adding a user. Select "Yes" and enter the device password that was set when first registering the product (P.15 or P.17). If you have forgotten the device password, refer to "When resetting the WLAN Adaptor because you have forgotten the password.", and reset the WLAN Adaptor to the manufacturing default condition.

Others

<p>To transfer or dispose the WLAN Adaptor.</p> <p>When resetting the WLAN Adaptor because you have forgotten the password.</p>	<p>Reset the WLAN Adaptor to manufacturing default condition.</p> <ol style="list-style-type: none">1. Press and hold the "SETUP" button on the WLAN Adaptor for 30 seconds.2. After releasing the "SETUP" button on the WLAN Adaptor, press the "RESET" button on the WLAN Adaptor.3. Once LINK LED has gone out, the factory reset is complete. <p>To unregister the air conditioner unit from "Panasonic Comfort Cloud" app, select the Menu and choose "Device list" to delete the set unit.</p>
<p>Operations are not possible from the smartphone.</p>	<p>Check the following:</p> <ul style="list-style-type: none">• Ensure that the function is supported by the air conditioner.• Ensure that remote controller operation is not disabled by the central control device.

Firmware Update Function

This product has functionality for connecting to the Panasonic firmware update server over the Internet to automatically update the device firmware to the latest version. To update the firmware, the device will do check, once per day, whether its firmware is the latest version after power up. And if an update is required, the update is applied and the device restarts automatically. Operations are not possible while the device is being restarted (Requires a maximum of five minutes).



Declaration of Conformity (DOC)

Hereby, "Panasonic Corporation" declares that this product is in compliance with the essential requirements and other relevant provisions of Directive 2014/53/EU

The full text of the EU declaration of conformity is available at the following internet address:

<http://www.ptc.panasonic.eu/>

Authorized Representative: Panasonic Testing Centre, Panasonic Marketing Europe GmbH, Winsbergring 15, 22525 Hamburg, Germany

Norway: There are usage restrictions within a radius of 20 km from the centre of Ny-Alesund on Svalbard.



Declaration of Conformity (DOC)

Hereby, "Panasonic Corporation" declares that this product is in compliance with the essential requirements and other relevant provisions of the relevant statutory requirements

The full text of the declaration of conformity is available at the following internet address:

<http://www.ptc.panasonic.eu/>

Contact in the UK :

Panasonic UK, a branch of Panasonic Marketing Europe GmbH, Maxis 2, Western Road, Bracknell, Berkshire, RG12 1RT

Copyright

- iOS is the name of the OS of Apple Inc. iOS is a trademark or registered trademark of Cisco in the US and other countries which has been licensed for use.
- Apple and the Apple logo are trademarks of Apple Inc. that are registered in the US and other countries. App Store is a service mark of Apple Inc.
- Android™, Google Play™ and Google Play™ logos are registered trademarks of Google LLC.
- "WPA™", "WPA2™", and "WPA3™" are the registered trademarks of the "Wi-Fi Alliance"SM.
- "QR Code" is a registered trademark of DENSO WAVE INCORPORATED.
- Other names, company names, product names, etc described in this manual are trademarks or registered trademarks of each company. In the text, some ™ and ® marks are not listed.

About Software

This product incorporates the following software:

- 1)The software developed independently by or for Panasonic Corporation,
 - 2)The software owned by third party and licensed to Panasonic Corporation,
 - 3)The licensed open-source software which meets conditions that make it unnecessary to release the source code
- Software that is categorized in (3) above may be distributed with the expectation that they are useful by themselves, but there is no implicit warranty that these will be able to be turned into products or made applicable for specific purposes, so no guarantee is made for them.

cJSON

Copyright (c) 2009 Dave Gamble

Copyright (c) 2009-2017 Dave Gamble and cJSON contributors

Permission is hereby granted, free of charge, to any person obtaining a copy of this software and associated documentation files (the "Software"), to deal in the Software without restriction, including without limitation the rights to use, copy, modify, merge, publish, distribute, sublicense, and/or sell copies of the Software, and to permit persons to whom the Software is furnished to do so, subject to the following conditions:

The above copyright notice and this permission notice shall be included in all copies or substantial portions of the Software.

THE SOFTWARE IS PROVIDED "AS IS", WITHOUT WARRANTY OF ANY KIND, EXPRESS OR IMPLIED, INCLUDING BUT NOT LIMITED TO THE WARRANTIES OF MERCHANTABILITY, FITNESS FOR A PARTICULAR PURPOSE AND NONINFRINGEMENT. IN NO EVENT SHALL THE AUTHORS OR COPYRIGHT HOLDERS BE LIABLE FOR ANY CLAIM, DAMAGES OR OTHER LIABILITY, WHETHER IN AN ACTION OF CONTRACT, TORT OR OTHERWISE, ARISING FROM, OUT OF OR IN CONNECTION WITH THE SOFTWARE OR THE USE OR OTHER DEALINGS IN THE SOFTWARE.

wpa_supplicant

Copyright (c) 2005-2009, Jouni Malinen <j@w1.fi>

Copyright (c) 2008, Jouni Malinen <j@w1.fi>

wpa_supplicant

=====

Copyright (c) 2003-2019, Jouni Malinen <j@w1.fi> and contributors All Rights Reserved.

This program is licensed under the BSD license (the one with advertisement clause removed).

If you are submitting changes to the project, please see CONTRIBUTIONS file for more instructions.

License

This software may be distributed, used, and modified under the terms of BSD license:

Redistribution and use in source and binary forms, with or without modification, are permitted provided that the following conditions are met:

1. Redistributions of source code must retain the above copyright notice, this list of conditions and the following disclaimer.
2. Redistributions in binary form must reproduce the above copyright notice, this list of conditions and the following disclaimer in the documentation and/or other materials provided with the distribution.
3. Neither the name(s) of the above-listed copyright holder(s) nor the names of its contributors may be used to endorse or promote products derived from this software without specific prior written permission.

THIS SOFTWARE IS PROVIDED BY THE COPYRIGHT HOLDERS AND CONTRIBUTORS "AS IS" AND ANY EXPRESS OR IMPLIED WARRANTIES, INCLUDING, BUT NOT LIMITED TO, THE IMPLIED WARRANTIES OF MERCHANTABILITY AND FITNESS FOR A PARTICULAR PURPOSE ARE DISCLAIMED. IN NO EVENT SHALL THE COPYRIGHT OWNER OR CONTRIBUTORS BE LIABLE FOR ANY DIRECT, INDIRECT, INCIDENTAL, SPECIAL, EXEMPLARY, OR CONSEQUENTIAL DAMAGES (INCLUDING, BUT NOT LIMITED TO, PROCUREMENT OF SUBSTITUTE GOODS OR SERVICES; LOSS OF USE, DATA, OR PROFITS; OR BUSINESS INTERRUPTION) HOWEVER CAUSED AND ON ANY THEORY OF LIABILITY, WHETHER IN CONTRACT, STRICT LIABILITY, OR TORT (INCLUDING NEGLIGENCE OR OTHERWISE) ARISING IN ANY WAY OUT OF THE USE OF THIS SOFTWARE, EVEN IF ADVISED OF THE POSSIBILITY OF SUCH DAMAGE.

Mbed TLS

Copyright (C) 2006-2015, ARM Limited, All Rights Reserved

Copyright (C) 2006-2016, ARM Limited, All Rights Reserved

Copyright (C) 2006-2017, ARM Limited, All Rights Reserved

Copyright (C) 2006-2018, ARM Limited, All Rights Reserved

Copyright (C) 2006-2018, ARM Limited (or its affiliates), All Rights Reserved

Copyright (C) 2006-2018, Arm Limited (or its affiliates), All Rights Reserved.

Copyright (C) 2006-2019, ARM Limited, All Rights Reserved

Copyright (C) 2006-2019, Arm Limited (or its affiliates), All Rights Reserved

Copyright (C) 2016, ARM Limited, All Rights Reserved

Copyright (C) 2016-2018, ARM Limited, All Rights Reserved

Copyright (C) 2018, Arm Limited (or its affiliates), All Rights Reserved

Copyright (C) 2018, Arm Limited, All Rights Reserved

RealtekSDK

(C) COPYRIGHT 2011 STMicroelectronics

(c) COPYRIGHT 2017 Realtek Semiconductor Corporation

Copyright (C) 2019 Amazon.com, Inc. or its affiliates. All Rights Reserved.

Copyright (c) 2006-2013 ARM Limited

Copyright (c) 2009-2016 ARM Limited. All rights reserved.

Copyright (c) 2009-2017 ARM Limited. All rights reserved.

Copyright (c) 2009-2018 Arm Limited. All rights reserved.

Copyright (c) 2013 ARM LIMITED All rights reserved.

Copyright (c) 2013 Realtek Semiconductor Corp.

Copyright (c) 2013-2016 Realtek Semiconductor Corp.

Copyright (c) 2014, Realtek Semiconductor Corp. All rights reserved.

Copyright (c) 2015, Realtek Semiconductor Corporation. All rights reserved.

Copyright (c) 2015, Realtek Semiconductor Corp. All rights reserved.

Copyright (c) 2015, Realtek Semiconductor Corporation. All rights reserved.

Copyright (c) 2017, Realtek Semiconductor Corporation. All rights reserved.

Copyright (c) 2017-2018 Arm Limited. All rights reserved.

Copyright 2014 Tencent. All rights reserved.

Copyright(c) 2007 - 2012 Realtek Corporation. All rights reserved.

Copyright(c) 2007 - 2016 Realtek Corporation. All rights reserved.

Copyright(c) 2007 - 2017 Realtek Corporation. All rights reserved.

Copyright(c) 2007 - 2018 Realtek Corporation. All rights reserved.

Copyright(c) 2014, Realtek Semiconductor Corporation. All rights reserved.

Copyright(c) 2015, Realtek Semiconductor Corporation. All rights reserved.

Copyright(c) 2016, Realtek Semiconductor Corporation. All rights reserved.

Copyright(c) 2017, Realtek Semiconductor Corporation. All rights reserved.

Copyright(c) 2019, Realtek Semiconductor Corporation. All rights reserved.

copyright Kulesh Shanmugasundaram (kulesh [squiggly] isis.poly.edu)

Apache License
Version 2.0, January 2004
<http://www.apache.org/licenses/>

TERMS AND CONDITIONS FOR USE, REPRODUCTION, AND DISTRIBUTION

1. Definitions.

"License" shall mean the terms and conditions for use, reproduction, and distribution as defined by Sections 1 through 9 of this document.

"Licensor" shall mean the copyright owner or entity authorized by the copyright owner that is granting the License.

"Legal Entity" shall mean the union of the acting entity and all other entities that control, are controlled by, or are under common control with that entity. For the purposes of this definition, "control" means (i) the power, direct or indirect, to cause the direction or management of such entity, whether by contract or otherwise, or (ii) ownership of fifty percent (50%) or more of the outstanding shares, or (iii) beneficial ownership of such entity.

"You" (or "Your") shall mean an individual or Legal Entity exercising permissions granted by this License.

"Source" form shall mean the preferred form for making modifications, including but not limited to software source code, documentation source, and configuration files.

"Object" form shall mean any form resulting from mechanical transformation or translation of a Source form, including but not limited to compiled object code, generated documentation, and conversions to other media types.

"Work" shall mean the work of authorship, whether in Source or Object form, made available under the License, as indicated by a copyright notice that is included in or attached to the work (an example is provided in the Appendix below).

"Derivative Works" shall mean any work, whether in Source or Object form, that is based on (or derived from) the Work and for which the editorial revisions, annotations, elaborations, or other modifications represent, as a whole, an original work of authorship. For the purposes of this License, Derivative Works shall not include works that remain separable from, or merely link (or bind by name) to the interfaces of, the Work and Derivative Works thereof.

"Contribution" shall mean any work of authorship, including the original version of the Work and any modifications or additions to that Work or Derivative Works thereof, that is intentionally submitted to Licensor for inclusion in the Work by the copyright owner or by an individual or Legal Entity authorized to submit on behalf of the copyright owner. For the purposes of this definition, "submitted" means any form of electronic, verbal, or written communication sent to the Licensor or its representatives, including but not limited to communication on electronic mailing lists, source code control systems, and issue tracking systems that are managed by, or on behalf of, the Licensor for the purpose of discussing and improving the Work, but excluding communication that is conspicuously marked or otherwise designated in writing by the copyright owner as "Not a Contribution."

"Contributor" shall mean Licensor and any individual or Legal Entity on behalf of whom a Contribution has been received by Licensor and subsequently incorporated within the Work.

2. Grant of Copyright License. Subject to the terms and conditions of this License, each Contributor hereby grants to You a perpetual, worldwide, non-exclusive, non-charge, royalty-free, irrevocable copyright license to reproduce, prepare Derivative Works of, publicly display, publicly perform, sublicense, and distribute the Work and such Derivative Works in Source or Object form.
3. Grant of Patent License. Subject to the terms and conditions of this License, each Contributor hereby grants to You a perpetual, worldwide, non-exclusive, non-charge, royalty-free, irrevocable (except as stated in this section) patent license to make, have made, use, offer to sell, sell, import, and otherwise transfer the Work, where such license applies only to those patent claims licensable by such Contributor that are necessarily infringed by their Contribution(s) alone or by combination of their Contribution(s) with the Work to which such Contribution(s) was submitted. If you institute patent litigation against any entity (including a cross-claim or counterclaim in a lawsuit) alleging that the Work or a Contribution incorporated within the Work constitutes direct or contributory patent infringement, then any patent licenses granted to You under this License for that Work shall terminate as of the date such litigation is filed.

4. Redistribution. You may reproduce and distribute copies of the Work or Derivative Works thereof in any medium, with or without modifications, and in Source or Object form, provided that You meet the following conditions:

- (a) You must give any other recipients of the Work or Derivative Works a copy of this License; and
- (b) You must cause any modified files to carry prominent notices stating that You changed the files; and
- (c) You must retain, in the Source form of any Derivative Works that You distribute, all copyright, patent, trademark, and attribution notices from the Source form of the Work, excluding those notices that do not pertain to any part of the Derivative Works; and
- (d) If the Work includes a "NOTICE" text file as part of its distribution, then any Derivative Works that You distribute must include a readable copy of the attribution notices contained within such NOTICE file, excluding those notices that do not pertain to any part of the Derivative Works, in at least one of the following places: within a NOTICE text file distributed as part of the Derivative Works; within the Source form or documentation, if provided along with the Derivative Works; or, within a display generated by the Derivative Works, if and wherever such third-party notices normally appear. The contents of the NOTICE file are for informational purposes only and do not modify the License. You may add Your own attribution notices within Derivative Works that You distribute, alongside or as an addendum to the NOTICE text from the Work, provided that such additional attribution notices cannot be construed as modifying the License.

You may add Your own copyright statement to Your modifications and may provide additional or different license terms and conditions for use, reproduction, or distribution of Your modifications, or for any such Derivative Works as a whole, provided Your use, reproduction, and distribution of the Work otherwise complies with the conditions stated in this License.

5. Submission of Contributions. Unless You explicitly state otherwise, any Contribution intentionally submitted for inclusion in the Work by You to the Licensor shall be under the terms and conditions of this License, without any additional terms or conditions. Notwithstanding the above, nothing herein shall supersede or modify the terms of any separate license agreement you may have executed with Licensor regarding such Contributions.
6. Trademarks. This License does not grant permission to use the trade names, trademarks, service marks, or product names of the Licensor, except as required for reasonable and customary use in describing the origin of the Work and reproducing the content of the NOTICE file.
7. Disclaimer of Warranty. Unless required by applicable law or agreed to in writing, Licensor provides the Work (and each Contributor provides its Contributions) on an "AS IS" BASIS, WITHOUT WARRANTIES OR CONDITIONS OF ANY KIND, either express or implied, including, without limitation, any warranties or conditions of TITLE, NON-INFRINGEMENT, MERCHANTABILITY, or FITNESS FOR A PARTICULAR PURPOSE. You are solely responsible for determining the appropriateness of using or redistributing the Work and assume any risks associated with Your exercise of permissions under this License.
8. Limitation of Liability. In no event and under no legal theory, whether in tort (including negligence), contract, or otherwise, unless required by applicable law (such as deliberate and grossly negligent acts) or agreed to in writing, shall any Contributor be liable to You for damages, including any direct, indirect, special, incidental, or consequential damages of any character arising as a result of this License or out of the use or inability to use the Work (including but not limited to damages for loss of goodwill, work stoppage, computer failure or malfunction, or any and all other commercial damages or losses), even if such Contributor has been advised of the possibility of such damages.
9. Accepting Warranty or Additional Liability. While redistributing the Work or Derivative Works thereof, You may choose to offer, and charge a fee for, acceptance of support, warranty, indemnity, or other liability obligations and/or rights consistent with this License. However, in accepting such obligations, You may act only on Your own behalf and on Your sole responsibility, not on behalf of any other Contributor, and only if You agree to indemnify, defend, and hold each Contributor harmless for any liability incurred by, or claims asserted against, such Contributor by reason of your accepting any such warranty or additional liability.

END OF TERMS AND CONDITIONS

APPENDIX: How to apply the Apache License to your work.

Author: Adam Dunkels <adam@sics.se>

*/

To apply the Apache License to your work, attach the following boilerplate notice, with the fields enclosed by brackets "[]" replaced with your own identifying information. (Don't include the brackets!) The text should be enclosed in the appropriate comment syntax for the file format. We also recommend that a file or class name and description of purpose be included on the same "printed page" as the copyright notice for easier identification within third-party archives.

Copyright [yyyy] [name of copyright owner]

Licensed under the Apache License, Version 2.0 (the "License"); you may not use this file except in compliance with the License. You may obtain a copy of the License at

http://www.apache.org/licenses/LICENSE-2.0

Unless required by applicable law or agreed to in writing, software distributed under the License is distributed on an "AS IS" BASIS, WITHOUT WARRANTIES OR CONDITIONS OF ANY KIND, either express or implied.

See the License for the specific language governing permissions and limitations under the License.

lwIP

- Copyright (c) 1997 Global Election Systems Inc.
Copyright (c) 2001-2003 Swedish Institute of Computer Science.
Copyright (c) 2001-2003 Swedish Institute of Computer Science. All rights reserved.
Copyright (c) 2001-2004 Axon Digital Design B.V., The Netherlands. All rights reserved.
Copyright (c) 2001-2004 Leon Woestenberg <leon.woestenberg@gmx.net>
Copyright (c) 2001-2004 Swedish Institute of Computer Science. All rights reserved.
Copyright (c) 2002 CITEL Technologies Ltd. All rights reserved.
Copyright (c) 2002-2003, Adam Dunkels.
Copyright (c) 2002-2003, Adam Dunkels. All rights reserved.
Copyright (c) 2003 by Marc Boucher, Services Informatiques (MBSI) inc.
Copyright (c) 2003-2004 Axon Digital Design B.V., The Netherlands. All rights reserved.
Copyright (c) 2003-2004 Leon Woestenberg <leon.woestenberg@axon.tv>
Copyright (c) 2007 Dominik Spies <kontakt@dspiess.de> All rights reserved.
Copyright (c) 2010 Inico Technologies Ltd. All rights reserved.
Copyright (c) 2016 The MINIX 3 Project. All rights reserved.

- *
*/
* Copyright (c) 2001, 2002 Swedish Institute of Computer Science.
* All rights reserved.
*
* Redistribution and use in source and binary forms, with or without
* modification, are permitted provided that the following conditions are
* met:
*
* 1. Redistributions of source code must retain the above copyright notice,
* this list of conditions and the following disclaimer.
* 2. Redistributions in binary form must reproduce the above copyright
* notice, this list of conditions and the following disclaimer in the
* documentation and/or other materials provided with the distribution.
* 3. The name of the author may not be used to endorse or promote
* products derived from this software without specific prior written
* permission.
*
* THIS SOFTWARE IS PROVIDED BY THE AUTHOR "AS IS" AND
* ANY EXPRESS OR IMPLIED WARRANTIES, INCLUDING, BUT NOT
* LIMITED TO, THE IMPLIED WARRANTIES OF MERCHANTABILITY
* AND FITNESS FOR A PARTICULAR PURPOSE ARE DISCLAIMED.
* IN NO EVENT SHALL THE AUTHOR BE LIABLE FOR ANY
* DIRECT, INDIRECT, INCIDENTAL, SPECIAL, EXEMPLARY, OR
* CONSEQUENTIAL DAMAGES (INCLUDING, BUT NOT LIMITED TO,
* PROCUREMENT OF SUBSTITUTE GOODS OR SERVICES; LOSS
* OF USE, DATA, OR PROFITS; OR BUSINESS INTERRUPTION)
* HOWEVER CAUSED AND ON ANY THEORY OF LIABILITY,
* WHETHER IN CONTRACT, STRICT LIABILITY, OR TORT (INCLUDING
* NEGLIGENCE OR OTHERWISE) ARISING IN ANY WAY OUT OF THE
* USE OF THIS SOFTWARE, EVEN IF ADVISED OF THE POSSIBILITY
* OF SUCH DAMAGE.
*
* This file is part of the lwIP TCP/IP stack.

FreeRTOS

Copyright (C) 2017 Amazon.com, Inc. or its affiliates. All Rights Reserved.
Copyright (C) 2019 Amazon.com, Inc. or its affiliates. All Rights Reserved.

The FreeRTOS kernel is released under the MIT open source license, the text of which is provided below.

This license covers the FreeRTOS kernel source files, which are located in the /FreeRTOS/Source directory of the official FreeRTOS kernel download. It also covers most of the source files in the demo application projects, which are located in the /FreeRTOS/Demo directory of the official FreeRTOS download. The demo projects may also include third party software that is not part of FreeRTOS and is licensed separately to FreeRTOS. Examples of third party software includes header files provided by chip or tools vendors, linker scripts, peripheral drivers, etc. All the software in subdirectories of the /FreeRTOS directory is either open source or distributed with permission, and is free for use. For the avoidance of doubt, refer to the comments at the top of each source file.

License text:

Copyright (C) 2019 Amazon.com, Inc. or its affiliates. All Rights Reserved. Permission is hereby granted, free of charge, to any person obtaining a copy of this software and associated documentation files (the "Software"), to deal in the Software without restriction, including without limitation the rights to use, copy, modify, merge, publish, distribute, sublicense, and/or sell copies of the Software, and to permit persons to whom the Software is furnished to do so, subject to the following conditions:

The above copyright notice and this permission notice shall be included in all copies or substantial portions of the Software.

THE SOFTWARE IS PROVIDED "AS IS", WITHOUT WARRANTY OF ANY KIND, EXPRESS OR IMPLIED, INCLUDING BUT NOT LIMITED TO THE WARRANTIES OF MERCHANTABILITY, FITNESS FOR A PARTICULAR PURPOSE AND NONINFRINGEMENT. IN NO EVENT SHALL THE AUTHORS OR COPYRIGHT HOLDERS BE LIABLE FOR ANY CLAIM, DAMAGES OR OTHER LIABILITY, WHETHER IN AN ACTION OF CONTRACT, TORT OR OTHERWISE, ARISING FROM, OUT OF OR IN CONNECTION WITH THE SOFTWARE OR THE USE OR OTHER DEALINGS IN THE SOFTWARE.

newlib

The newlib subdirectory is a collection of software from several sources.

Each file may have its own copyright/license that is embedded in the source file. Unless otherwise noted in the body of the source file(s), the following copyright notices will apply to the contents of the newlib subdirectory:

(1) Red Hat Incorporated

Copyright (c) 1994-2009 Red Hat, Inc. All rights reserved.

This copyrighted material is made available to anyone wishing to use, modify, copy, or redistribute it subject to the terms and conditions of the BSD License. This program is distributed in the hope that it will be useful, but WITHOUT ANY WARRANTY expressed or implied, including the implied warranties of MERCHANTABILITY or FITNESS FOR A PARTICULAR PURPOSE. A copy of this license is available at http://www.opensource.org/licenses. Any Red Hat trademarks that are incorporated in the source code or documentation are not subject to the BSD License and may only be used or replicated with the express permission of Red Hat, Inc.

(2) University of California, Berkeley

Copyright (c) 1981-2000 The Regents of the University of California. All rights reserved.

Redistribution and use in source and binary forms, with or without modification, are permitted provided that the following conditions are met:

- * Redistributions of source code must retain the above copyright notice, this list of conditions and the following disclaimer.
- * Redistributions in binary form must reproduce the above copyright notice, this list of conditions and the following disclaimer in the documentation and/or other materials provided with the distribution.
- * Neither the name of the University nor the names of its contributors may be used to endorse or promote products derived from this software without specific prior written permission.

THIS SOFTWARE IS PROVIDED BY THE COPYRIGHT HOLDERS AND CONTRIBUTORS "AS IS" AND ANY EXPRESS OR IMPLIED WARRANTIES, INCLUDING, BUT NOT LIMITED TO, THE IMPLIED WARRANTIES OF MERCHANTABILITY AND FITNESS FOR A PARTICULAR PURPOSE ARE DISCLAIMED. IN NO EVENT SHALL THE COPYRIGHT OWNER OR CONTRIBUTORS BE LIABLE FOR ANY DIRECT, INDIRECT, INCIDENTAL, SPECIAL, EXEMPLARY, OR CONSEQUENTIAL DAMAGES (INCLUDING, BUT NOT LIMITED TO, PROCUREMENT OF SUBSTITUTE GOODS OR SERVICES; LOSS OF USE, DATA, OR PROFITS; OR BUSINESS INTERRUPTION) HOWEVER CAUSED AND ON ANY THEORY OF LIABILITY, WHETHER IN CONTRACT, STRICT LIABILITY, OR TORT (INCLUDING NEGLIGENCE OR OTHERWISE) ARISING IN ANY WAY OUT OF THE USE OF THIS SOFTWARE, EVEN IF ADVISED OF THE POSSIBILITY OF SUCH DAMAGE.

(3) David M. Gay (AT&T 1991, Lucent 1998)

The author of this software is David M. Gay.

Copyright (c) 1991 by AT&T.

Permission to use, copy, modify, and distribute this software for any purpose without fee is hereby granted, provided that this entire notice is included in all copies of any software which is or includes a copy or modification of this software and in all copies of the supporting documentation for such software.

THIS SOFTWARE IS BEING PROVIDED "AS IS", WITHOUT ANY EXPRESS OR IMPLIED WARRANTY. IN PARTICULAR, NEITHER THE AUTHOR NOR AT&T MAKES ANY REPRESENTATION OR WARRANTY OF ANY KIND CONCERNING THE MERCHANTABILITY OF THIS SOFTWARE OR ITS FITNESS FOR ANY PARTICULAR PURPOSE.

The author of this software is David M. Gay.

Copyright (C) 1998-2001 by Lucent Technologies
All Rights Reserved

Permission to use, copy, modify, and distribute this software and its documentation for any purpose and without fee is hereby granted, provided that the above copyright notice appear in all copies and that both that the copyright notice and this permission notice and warranty disclaimer appear in supporting documentation, and that the name of Lucent or any of its entities not be used in advertising or publicity pertaining to distribution of the software without specific, written prior permission.

LUCENT DISCLAIMS ALL WARRANTIES WITH REGARD TO THIS SOFTWARE, INCLUDING ALL IMPLIED WARRANTIES OF MERCHANTABILITY AND FITNESS. IN NO EVENT SHALL LUCENT OR ANY OF ITS ENTITIES BE LIABLE FOR ANY SPECIAL, INDIRECT OR CONSEQUENTIAL DAMAGES OR ANY DAMAGES WHATSOEVER RESULTING FROM LOSS OF USE, DATA OR PROFITS, WHETHER IN AN ACTION OF CONTRACT, NEGLIGENCE OR OTHER TORTIOUS ACTION, ARISING OUT OF OR IN CONNECTION WITH THE USE OR PERFORMANCE OF THIS SOFTWARE.

(4) Advanced Micro Devices

Copyright 1989, 1990 Advanced Micro Devices, Inc.

This software is the property of Advanced Micro Devices, Inc (AMD) which specifically grants the user the right to modify, use and distribute this software provided this notice is not removed or altered. All other rights are reserved by AMD.

AMD MAKES NO WARRANTY OF ANY KIND, EXPRESS OR IMPLIED, WITH REGARD TO THIS SOFTWARE. IN NO EVENT SHALL AMD BE LIABLE FOR INCIDENTAL OR CONSEQUENTIAL DAMAGES

IN CONNECTION WITH OR ARISING FROM THE FURNISHING, PERFORMANCE, OR USE OF THIS SOFTWARE.

So that all may benefit from your experience, please report any problems or suggestions about this software to the 29K Technical Support Center at 800-29-29-AMD (800-292-9263) in the USA, or 0800-89-1131 in the UK, or 0031-11-1129 in Japan, toll free. The direct dial number is 512-462-4118.

Advanced Micro Devices, Inc.
29K Support Products
Mail Stop 573
5900 E. Ben White Blvd.
Austin, TX 78741
800-292-9263

(7) Sun Microsystems

Copyright (C) 1993 by Sun Microsystems, Inc. All rights reserved.

Developed at SunPro, a Sun Microsystems, Inc. business. Permission to use, copy, modify, and distribute this software is freely granted, provided that this notice is preserved.

(8) Hewlett Packard

(c) Copyright 1986 HEWLETT-PACKARD COMPANY

To anyone who acknowledges that this file is provided "AS IS" without any express or implied warranty:

permission to use, copy, modify, and distribute this file for any purpose is hereby granted without fee, provided that the above copyright notice and this notice appears in all copies, and that the name of Hewlett-Packard Company not be used in advertising or publicity pertaining to distribution of the software without specific, written prior permission. Hewlett-Packard Company makes no representations about the suitability of this software for any purpose.

(9) Hans-Peter Nilsson

Copyright (C) 2001 Hans-Peter Nilsson

Permission to use, copy, modify, and distribute this software is freely granted, provided that the above copyright notice, this notice and the following disclaimer are preserved with no changes.

THIS SOFTWARE IS PROVIDED "AS IS" AND WITHOUT ANY EXPRESS OR IMPLIED WARRANTIES, INCLUDING, WITHOUT LIMITATION, THE IMPLIED WARRANTIES OF MERCHANTABILITY AND FITNESS FOR A PARTICULAR PURPOSE.

(11) Christopher G. Demetriou

Copyright (c) 2001 Christopher G. Demetriou
All rights reserved.

Redistribution and use in source and binary forms, with or without modification, are permitted provided that the following conditions are met:

1. Redistributions of source code must retain the above copyright notice, this list of conditions and the following disclaimer.
2. Redistributions in binary form must reproduce the above copyright notice, this list of conditions and the following disclaimer in the documentation and/or other materials provided with the distribution.
3. The name of the author may not be used to endorse or promote products derived from this software without specific prior written permission.

THIS SOFTWARE IS PROVIDED BY THE AUTHOR "AS IS" AND ANY EXPRESS OR IMPLIED WARRANTIES, INCLUDING, BUT NOT LIMITED TO, THE IMPLIED WARRANTIES OF MERCHANTABILITY AND FITNESS FOR A PARTICULAR PURPOSE ARE DISCLAIMED. IN NO EVENT SHALL THE AUTHOR BE LIABLE FOR ANY DIRECT, INDIRECT, INCIDENTAL, SPECIAL, EXEMPLARY, OR CONSEQUENTIAL DAMAGES (INCLUDING, BUT NOT LIMITED TO, PROCUREMENT OF SUBSTITUTE GOODS OR SERVICES; LOSS OF USE, DATA, OR PROFITS; OR BUSINESS INTERRUPTION) HOWEVER CAUSED AND ON ANY THEORY OF LIABILITY, WHETHER IN CONTRACT, STRICT LIABILITY, OR TORT (INCLUDING NEGLIGENCE OR OTHERWISE) ARISING IN ANY WAY OUT OF THE USE OF THIS SOFTWARE, EVEN IF ADVISED OF THE POSSIBILITY OF SUCH DAMAGE.

(12) SuperH, Inc.

Copyright 2002 SuperH, Inc. All rights reserved

This software is the property of SuperH, Inc (SuperH) which specifically grants the user the right to modify, use and distribute this software provided this notice is not removed or altered. All other rights are reserved by SuperH.

SUPERH MAKES NO WARRANTY OF ANY KIND, EXPRESS OR IMPLIED, WITH REGARD TO THIS SOFTWARE. IN NO EVENT SHALL SUPERH BE LIABLE FOR INDIRECT, SPECIAL, INCIDENTAL OR CONSEQUENTIAL DAMAGES IN CONNECTION WITH OR ARISING FROM THE FURNISHING, PERFORMANCE, OR USE OF THIS SOFTWARE.

So that all may benefit from your experience, please report any problems or suggestions about this software to the SuperH Support Center via e-mail at softwaresupport@superh.com.

SuperH, Inc.
405 River Oaks Parkway
San Jose
CA 95134
USA

(13) Royal Institute of Technology

Copyright (c) 1999 Kungliga Tekniska Högskolan
(Royal Institute of Technology, Stockholm, Sweden).
All rights reserved.

Redistribution and use in source and binary forms, with or without modification, are permitted provided that the following conditions are met:

1. Redistributions of source code must retain the above copyright notice, this list of conditions and the following disclaimer.
2. Redistributions in binary form must reproduce the above copyright notice, this list of conditions and the following disclaimer in the documentation and/or other materials provided with the distribution.
3. Neither the name of KTH nor the names of its contributors may be used to endorse or promote products derived from this software without specific prior written permission.

THIS SOFTWARE IS PROVIDED BY KTH AND ITS CONTRIBUTORS "AS IS" AND ANY EXPRESS OR IMPLIED WARRANTIES, INCLUDING, BUT NOT LIMITED TO, THE IMPLIED WARRANTIES OF MERCHANTABILITY AND FITNESS FOR A PARTICULAR PURPOSE ARE DISCLAIMED. IN NO EVENT SHALL KTH OR ITS CONTRIBUTORS BE LIABLE FOR ANY DIRECT, INDIRECT, INCIDENTAL, SPECIAL, EXEMPLARY, OR CONSEQUENTIAL DAMAGES (INCLUDING, BUT NOT LIMITED TO, PROCUREMENT OF SUBSTITUTE GOODS OR SERVICES; LOSS OF USE, DATA, OR PROFITS; OR BUSINESS INTERRUPTION) HOWEVER CAUSED AND ON ANY THEORY OF LIABILITY, WHETHER IN CONTRACT, STRICT LIABILITY, OR TORT (INCLUDING NEGLIGENCE OR OTHERWISE) ARISING IN ANY WAY OUT OF THE USE OF THIS SOFTWARE, EVEN IF ADVISED OF THE POSSIBILITY OF SUCH DAMAGE.

(14) Alexey Zelkin

Copyright (c) 2000, 2001 Alexey Zelkin <phantom@FreeBSD.org>
All rights reserved.

Redistribution and use in source and binary forms, with or without modification, are permitted provided that the following conditions are met:

1. Redistributions of source code must retain the above copyright notice, this list of conditions and the following disclaimer.
2. Redistributions in binary form must reproduce the above copyright notice, this list of conditions and the following disclaimer in the documentation and/or other materials provided with the distribution.

THIS SOFTWARE IS PROVIDED BY THE AUTHOR AND CONTRIBUTORS "AS IS" AND ANY EXPRESS OR IMPLIED WARRANTIES, INCLUDING, BUT NOT LIMITED TO, THE IMPLIED WARRANTIES OF MERCHANTABILITY AND FITNESS FOR A PARTICULAR PURPOSE ARE DISCLAIMED. IN NO EVENT SHALL THE AUTHOR OR CONTRIBUTORS BE LIABLE FOR ANY DIRECT, INDIRECT, INCIDENTAL, SPECIAL, EXEMPLARY, OR CONSEQUENTIAL DAMAGES (INCLUDING, BUT NOT LIMITED TO, PROCUREMENT

OF SUBSTITUTE GOODS OR SERVICES; LOSS OF USE, DATA, OR PROFITS; OR BUSINESS INTERRUPTION) HOWEVER CAUSED AND ON ANY THEORY OF LIABILITY, WHETHER IN CONTRACT, STRICT LIABILITY, OR TORT (INCLUDING NEGLIGENCE OR OTHERWISE) ARISING IN ANY WAY OUT OF THE USE OF THIS SOFTWARE, EVEN IF ADVISED OF THE POSSIBILITY OF SUCH DAMAGE.

(15) Andrey A. Chernov

Copyright (C) 1997 by Andrey A. Chernov, Moscow, Russia.
All rights reserved.

Redistribution and use in source and binary forms, with or without modification, are permitted provided that the following conditions are met:

1. Redistributions of source code must retain the above copyright notice, this list of conditions and the following disclaimer.
2. Redistributions in binary form must reproduce the above copyright notice, this list of conditions and the following disclaimer in the documentation and/or other materials provided with the distribution.

THIS SOFTWARE IS PROVIDED BY THE AUTHOR "AS IS" AND ANY EXPRESS OR IMPLIED WARRANTIES, INCLUDING, BUT NOT LIMITED TO, THE IMPLIED WARRANTIES OF MERCHANTABILITY AND FITNESS FOR A PARTICULAR PURPOSE ARE DISCLAIMED. IN NO EVENT SHALL THE REGENTS OR CONTRIBUTORS BE LIABLE FOR ANY DIRECT, INDIRECT, INCIDENTAL, SPECIAL, EXEMPLARY, OR CONSEQUENTIAL DAMAGES (INCLUDING, BUT NOT LIMITED TO, PROCUREMENT OF SUBSTITUTE GOODS OR SERVICES; LOSS OF USE, DATA, OR PROFITS; OR BUSINESS INTERRUPTION) HOWEVER CAUSED AND ON ANY THEORY OF LIABILITY, WHETHER IN CONTRACT, STRICT LIABILITY, OR TORT (INCLUDING NEGLIGENCE OR OTHERWISE) ARISING IN ANY WAY OUT OF THE USE OF THIS SOFTWARE, EVEN IF ADVISED OF THE POSSIBILITY OF SUCH DAMAGE.

(16) FreeBSD

Copyright (c) 1997-2002 FreeBSD Project.
All rights reserved.

Redistribution and use in source and binary forms, with or without modification, are permitted provided that the following conditions are met:

1. Redistributions of source code must retain the above copyright notice, this list of conditions and the following disclaimer.
2. Redistributions in binary form must reproduce the above copyright notice, this list of conditions and the following disclaimer in the documentation and/or other materials provided with the distribution.

THIS SOFTWARE IS PROVIDED BY THE AUTHOR AND CONTRIBUTORS "AS IS" AND ANY EXPRESS OR IMPLIED WARRANTIES, INCLUDING, BUT NOT LIMITED TO, THE IMPLIED WARRANTIES OF MERCHANTABILITY AND FITNESS FOR A PARTICULAR PURPOSE ARE DISCLAIMED. IN NO EVENT SHALL THE AUTHOR OR CONTRIBUTORS BE LIABLE FOR ANY DIRECT, INDIRECT, INCIDENTAL, SPECIAL, EXEMPLARY, OR CONSEQUENTIAL DAMAGES (INCLUDING, BUT NOT LIMITED TO, PROCUREMENT OF SUBSTITUTE GOODS OR SERVICES; LOSS OF USE, DATA, OR PROFITS; OR BUSINESS INTERRUPTION) HOWEVER CAUSED AND ON ANY THEORY OF LIABILITY, WHETHER IN CONTRACT, STRICT LIABILITY, OR TORT (INCLUDING NEGLIGENCE OR OTHERWISE) ARISING IN ANY WAY OUT OF THE USE OF THIS SOFTWARE, EVEN IF ADVISED OF THE POSSIBILITY OF SUCH DAMAGE.

(17) S. L. Moshier

Author: S. L. Moshier.

Copyright (c) 1984,2000 S.L. Moshier

Permission to use, copy, modify, and distribute this software for any purpose without fee is hereby granted, provided that this entire notice is included in all copies of any software which is or includes a copy or modification of this software and in all copies of the supporting documentation for such software.

THIS SOFTWARE IS BEING PROVIDED "AS IS", WITHOUT ANY EXPRESS OR IMPLIED WARRANTY. IN PARTICULAR, THE AUTHOR MAKES NO REPRESENTATION OR WARRANTY OF ANY KIND CONCERNING THE MERCHANTABILITY OF THIS SOFTWARE OR ITS FITNESS FOR ANY PARTICULAR PURPOSE.

(18) Citrus Project

Copyright (c)1999 Citrus Project,
All rights reserved.

Redistribution and use in source and binary forms, with or without modification, are permitted provided that the following conditions are met:

1. Redistributions of source code must retain the above copyright notice, this list of conditions and the following disclaimer.
2. Redistributions in binary form must reproduce the above copyright notice, this list of conditions and the following disclaimer in the documentation and/or other materials provided with the distribution.

THIS SOFTWARE IS PROVIDED BY THE AUTHOR AND CONTRIBUTORS "AS IS" AND ANY EXPRESS OR IMPLIED WARRANTIES, INCLUDING, BUT NOT LIMITED TO, THE IMPLIED WARRANTIES OF MERCHANTABILITY AND FITNESS FOR A PARTICULAR PURPOSE ARE DISCLAIMED. IN NO EVENT SHALL THE AUTHOR OR CONTRIBUTORS BE LIABLE FOR ANY DIRECT, INDIRECT, INCIDENTAL, SPECIAL, EXEMPLARY, OR CONSEQUENTIAL DAMAGES (INCLUDING, BUT NOT LIMITED TO, PROCUREMENT OF SUBSTITUTE GOODS OR SERVICES; LOSS OF USE, DATA, OR PROFITS; OR BUSINESS INTERRUPTION) HOWEVER CAUSED AND ON ANY THEORY OF LIABILITY, WHETHER IN CONTRACT, STRICT LIABILITY, OR TORT (INCLUDING NEGLIGENCE OR OTHERWISE) ARISING IN ANY WAY OUT OF THE USE OF THIS SOFTWARE, EVEN IF ADVISED OF THE POSSIBILITY OF SUCH DAMAGE.

(19) Todd C. Miller

Copyright (c) 1998 Todd C. Miller <Todd.Miller@courtesan.com>
All rights reserved.

Redistribution and use in source and binary forms, with or without modification, are permitted provided that the following conditions are met:

1. Redistributions of source code must retain the above copyright notice, this list of conditions and the following disclaimer.
2. Redistributions in binary form must reproduce the above copyright notice, this list of conditions and the following disclaimer in the documentation and/or other materials provided with the distribution.
3. The name of the author may not be used to endorse or promote products derived from this software without specific prior written permission.

THIS SOFTWARE IS PROVIDED "AS IS" AND ANY EXPRESS OR IMPLIED WARRANTIES, INCLUDING, BUT NOT LIMITED TO, THE IMPLIED WARRANTIES OF MERCHANTABILITY AND FITNESS FOR A PARTICULAR PURPOSE ARE DISCLAIMED. IN NO EVENT SHALL THE AUTHOR BE LIABLE FOR ANY DIRECT, INDIRECT, INCIDENTAL, SPECIAL, EXEMPLARY, OR CONSEQUENTIAL DAMAGES (INCLUDING, BUT NOT LIMITED TO, PROCUREMENT OF SUBSTITUTE GOODS OR SERVICES; LOSS OF USE, DATA, OR PROFITS; OR BUSINESS INTERRUPTION) HOWEVER CAUSED AND ON ANY THEORY OF LIABILITY, WHETHER IN CONTRACT, STRICT LIABILITY, OR TORT (INCLUDING NEGLIGENCE OR OTHERWISE) ARISING IN ANY WAY OUT OF THE USE OF THIS SOFTWARE, EVEN IF ADVISED OF THE POSSIBILITY OF SUCH DAMAGE.

(20) DJ Delorie (i386)

Copyright (C) 1991 DJ Delorie
All rights reserved.

Redistribution, modification, and use in source and binary forms is permitted provided that the above copyright notice and following paragraph are duplicated in all such forms.

This file is distributed WITHOUT ANY WARRANTY; without even the implied warranty of MERCHANTABILITY or FITNESS FOR A PARTICULAR PURPOSE.

(23) Intel (i960)

Copyright (c) 1993 Intel Corporation

Intel hereby grants you permission to copy, modify, and distribute this software and its documentation. Intel grants this permission provided that the above copyright notice appears in all copies and that both the copyright notice and this permission notice appear in supporting documentation. In addition, Intel grants this permission provided that you prominently mark as "not part of the original" any modifications made to this software or documentation, and that the name of Intel Corporation not be used in advertising or publicity pertaining to distribution of the software or the

documentation without specific, written prior permission.

Intel Corporation provides this AS IS, WITHOUT ANY WARRANTY, EXPRESS OR IMPLIED, INCLUDING, WITHOUT LIMITATION, ANY WARRANTY OF MERCHANTABILITY OR FITNESS FOR A PARTICULAR PURPOSE. Intel makes no guarantee or representations regarding the use of, or the results of the use of, the software and documentation in terms of correctness, accuracy, reliability, currentness, or otherwise; and you rely on the software, documentation and results solely at your own risk.

IN NO EVENT SHALL INTEL BE LIABLE FOR ANY LOSS OF USE, LOSS OF BUSINESS, LOSS OF PROFITS, INDIRECT, INCIDENTAL, SPECIAL OR CONSEQUENTIAL DAMAGES OF ANY KIND. IN NO EVENT SHALL INTEL'S TOTAL LIABILITY EXCEED THE SUM PAID TO INTEL FOR THE PRODUCT LICENSED HEREUNDER.

(26) Mike Barcroft

Copyright (c) 2001 Mike Barcroft <mike@FreeBSD.org>
All rights reserved.

Redistribution and use in source and binary forms, with or without modification, are permitted provided that the following conditions are met:

1. Redistributions of source code must retain the above copyright notice, this list of conditions and the following disclaimer.
2. Redistributions in binary form must reproduce the above copyright notice, this list of conditions and the following disclaimer in the documentation and/or other materials provided with the distribution.

THIS SOFTWARE IS PROVIDED BY THE AUTHOR AND CONTRIBUTORS "AS IS" AND ANY EXPRESS OR IMPLIED WARRANTIES, INCLUDING, BUT NOT LIMITED TO, THE IMPLIED WARRANTIES OF MERCHANTABILITY AND FITNESS FOR A PARTICULAR PURPOSE ARE DISCLAIMED. IN NO EVENT SHALL THE AUTHOR OR CONTRIBUTORS BE LIABLE FOR ANY DIRECT, INDIRECT, INCIDENTAL, SPECIAL, EXEMPLARY, OR CONSEQUENTIAL DAMAGES (INCLUDING, BUT NOT LIMITED TO, PROCUREMENT OF SUBSTITUTE GOODS OR SERVICES; LOSS OF USE, DATA, OR PROFITS; OR BUSINESS INTERRUPTION) HOWEVER CAUSED AND ON ANY THEORY OF LIABILITY, WHETHER IN CONTRACT, STRICT LIABILITY, OR TORT (INCLUDING NEGLIGENCE OR OTHERWISE) ARISING IN ANY WAY OUT OF THE USE OF THIS SOFTWARE, EVEN IF ADVISED OF THE POSSIBILITY OF SUCH DAMAGE.

(27) Konstantin Chuguev (--enable-newlib-iconv)

Copyright (c) 1999, 2000
Konstantin Chuguev. All rights reserved.

Redistribution and use in source and binary forms, with or without modification, are permitted provided that the following conditions are met:

1. Redistributions of source code must retain the above copyright notice, this list of conditions and the following disclaimer.
2. Redistributions in binary form must reproduce the above copyright notice, this list of conditions and the following disclaimer in the documentation and/or other materials provided with the distribution.

THIS SOFTWARE IS PROVIDED BY THE AUTHOR AND CONTRIBUTORS "AS IS" AND ANY EXPRESS OR IMPLIED WARRANTIES, INCLUDING, BUT NOT LIMITED TO, THE IMPLIED WARRANTIES OF MERCHANTABILITY AND FITNESS FOR A PARTICULAR PURPOSE ARE DISCLAIMED. IN NO EVENT SHALL THE AUTHOR OR CONTRIBUTORS BE LIABLE FOR ANY DIRECT, INDIRECT, INCIDENTAL, SPECIAL, EXEMPLARY, OR CONSEQUENTIAL DAMAGES (INCLUDING, BUT NOT LIMITED TO, PROCUREMENT OF SUBSTITUTE GOODS OR SERVICES; LOSS OF USE, DATA, OR PROFITS; OR BUSINESS INTERRUPTION) HOWEVER CAUSED AND ON ANY THEORY OF LIABILITY, WHETHER IN CONTRACT, STRICT LIABILITY, OR TORT (INCLUDING NEGLIGENCE OR OTHERWISE) ARISING IN ANY WAY OUT OF THE USE OF THIS SOFTWARE, EVEN IF ADVISED OF THE POSSIBILITY OF SUCH DAMAGE.

iconv (Charsel Conversion Library) v2.0

(28) Artem Bityuckiy (--enable-newlib-iconv)

Copyright (c) 2003, Artem B. Bityuckiy, SoftMine Corporation.
Rights transferred to Franklin Electronic Publishers.

Redistribution and use in source and binary forms, with or without modification, are permitted provided that the following conditions are met:

1. Redistributions of source code must retain the above copyright notice,

this list of conditions and the following disclaimer.

2. Redistributions in binary form must reproduce the above copyright notice, this list of conditions and the following disclaimer in the documentation and/or other materials provided with the distribution.

THIS SOFTWARE IS PROVIDED BY THE AUTHOR AND CONTRIBUTORS "AS IS" AND ANY EXPRESS OR IMPLIED WARRANTIES, INCLUDING, BUT NOT LIMITED TO, THE IMPLIED WARRANTIES OF MERCHANTABILITY AND FITNESS FOR A PARTICULAR PURPOSE ARE DISCLAIMED. IN NO EVENT SHALL THE AUTHOR OR CONTRIBUTORS BE LIABLE FOR ANY DIRECT, INDIRECT, INCIDENTAL, SPECIAL, EXEMPLARY, OR CONSEQUENTIAL DAMAGES (INCLUDING, BUT NOT LIMITED TO, PROCUREMENT OF SUBSTITUTE GOODS OR SERVICES; LOSS OF USE, DATA, OR PROFITS; OR BUSINESS INTERRUPTION) HOWEVER CAUSED AND ON ANY THEORY OF LIABILITY, WHETHER IN CONTRACT, STRICT LIABILITY, OR TORT (INCLUDING NEGLIGENCE OR OTHERWISE) ARISING IN ANY WAY OUT OF THE USE OF THIS SOFTWARE, EVEN IF ADVISED OF THE POSSIBILITY OF SUCH DAMAGE.

(30) - Alex Tatmanjants (targets using libc/posix)

Copyright (c) 1995 Alex Tatmanjants <alex@elvisti.kiev.ua>
at Electronni Visti IA, Kiev, Ukraine.
All rights reserved.

Redistribution and use in source and binary forms, with or without modification, are permitted provided that the following conditions are met:

1. Redistributions of source code must retain the above copyright notice, this list of conditions and the following disclaimer.
2. Redistributions in binary form must reproduce the above copyright notice, this list of conditions and the following disclaimer in the documentation and/or other materials provided with the distribution.

THIS SOFTWARE IS PROVIDED BY THE AUTHOR "AS IS" AND ANY EXPRESS OR IMPLIED WARRANTIES, INCLUDING, BUT NOT LIMITED TO, THE IMPLIED WARRANTIES OF MERCHANTABILITY AND FITNESS FOR A PARTICULAR PURPOSE ARE DISCLAIMED. IN NO EVENT SHALL THE AUTHOR BE LIABLE FOR ANY DIRECT, INDIRECT, INCIDENTAL, SPECIAL, EXEMPLARY, OR CONSEQUENTIAL DAMAGES (INCLUDING, BUT NOT LIMITED TO, PROCUREMENT OF SUBSTITUTE GOODS OR SERVICES; LOSS OF USE, DATA, OR PROFITS; OR BUSINESS INTERRUPTION) HOWEVER CAUSED AND ON ANY THEORY OF LIABILITY, WHETHER IN CONTRACT, STRICT LIABILITY, OR TORT (INCLUDING NEGLIGENCE OR OTHERWISE) ARISING IN ANY WAY OUT OF THE USE OF THIS SOFTWARE, EVEN IF ADVISED OF THE POSSIBILITY OF SUCH DAMAGE.

(31) - M. Warner Losh (targets using libc/posix)

Copyright (c) 1998, M. Warner Losh <imp@freebsd.org>
All rights reserved.

Redistribution and use in source and binary forms, with or without modification, are permitted provided that the following conditions are met:

1. Redistributions of source code must retain the above copyright notice, this list of conditions and the following disclaimer.
2. Redistributions in binary form must reproduce the above copyright notice, this list of conditions and the following disclaimer in the documentation and/or other materials provided with the distribution.

THIS SOFTWARE IS PROVIDED BY THE AUTHOR AND CONTRIBUTORS "AS IS" AND ANY EXPRESS OR IMPLIED WARRANTIES, INCLUDING, BUT NOT LIMITED TO, THE IMPLIED WARRANTIES OF MERCHANTABILITY AND FITNESS FOR A PARTICULAR PURPOSE ARE DISCLAIMED. IN NO EVENT SHALL THE AUTHOR OR CONTRIBUTORS BE LIABLE FOR ANY DIRECT, INDIRECT, INCIDENTAL, SPECIAL, EXEMPLARY, OR CONSEQUENTIAL DAMAGES (INCLUDING, BUT NOT LIMITED TO, PROCUREMENT OF SUBSTITUTE GOODS OR SERVICES; LOSS OF USE, DATA, OR PROFITS; OR BUSINESS INTERRUPTION) HOWEVER CAUSED AND ON ANY THEORY OF LIABILITY, WHETHER IN CONTRACT, STRICT LIABILITY, OR TORT (INCLUDING NEGLIGENCE OR OTHERWISE) ARISING IN ANY WAY OUT OF THE USE OF THIS SOFTWARE, EVEN IF ADVISED OF THE POSSIBILITY OF SUCH DAMAGE.

(32) - Andrey A. Chernov (targets using libc/posix)

Copyright (C) 1996 by Andrey A. Chernov, Moscow, Russia.
All rights reserved.

Redistribution and use in source and binary forms, with or without

modification, are permitted provided that the following conditions are met:

1. Redistributions of source code must retain the above copyright notice, this list of conditions and the following disclaimer.
2. Redistributions in binary form must reproduce the above copyright notice, this list of conditions and the following disclaimer in the documentation and/or other materials provided with the distribution.

THIS SOFTWARE IS PROVIDED BY THE AUTHOR "AS IS" AND ANY EXPRESS OR IMPLIED WARRANTIES, INCLUDING, BUT NOT LIMITED TO, THE IMPLIED WARRANTIES OF MERCHANTABILITY AND FITNESS FOR A PARTICULAR PURPOSE ARE DISCLAIMED. IN NO EVENT SHALL THE REGENTS OR CONTRIBUTORS BE LIABLE FOR ANY DIRECT, INDIRECT, INCIDENTAL, SPECIAL, EXEMPLARY, OR CONSEQUENTIAL DAMAGES (INCLUDING, BUT NOT LIMITED TO, PROCUREMENT OF SUBSTITUTE GOODS OR SERVICES; LOSS OF USE, DATA, OR PROFITS; OR BUSINESS INTERRUPTION) HOWEVER CAUSED AND ON ANY THEORY OF LIABILITY, WHETHER IN CONTRACT, STRICT LIABILITY, OR TORT (INCLUDING NEGLIGENCE OR OTHERWISE) ARISING IN ANY WAY OUT OF THE USE OF THIS SOFTWARE, EVEN IF ADVISED OF THE POSSIBILITY OF SUCH DAMAGE.

(33) - Daniel Eischen (targets using libc/posix)

Copyright (c) 2001 Daniel Eischen <deischen@FreeBSD.org>.
All rights reserved.

Redistribution and use in source and binary forms, with or without modification, are permitted provided that the following conditions are met:

1. Redistributions of source code must retain the above copyright notice, this list of conditions and the following disclaimer.
2. Redistributions in binary form must reproduce the above copyright notice, this list of conditions and the following disclaimer in the documentation and/or other materials provided with the distribution.

THIS SOFTWARE IS PROVIDED BY THE AUTHOR AND CONTRIBUTORS "AS IS" AND ANY EXPRESS OR IMPLIED WARRANTIES, INCLUDING, BUT NOT LIMITED TO, THE IMPLIED WARRANTIES OF MERCHANTABILITY AND FITNESS FOR A PARTICULAR PURPOSE ARE DISCLAIMED. IN NO EVENT SHALL THE REGENTS OR CONTRIBUTORS BE LIABLE FOR ANY DIRECT, INDIRECT, INCIDENTAL, SPECIAL, EXEMPLARY, OR CONSEQUENTIAL DAMAGES (INCLUDING, BUT NOT LIMITED TO, PROCUREMENT OF SUBSTITUTE GOODS OR SERVICES; LOSS OF USE, DATA, OR PROFITS; OR BUSINESS INTERRUPTION) HOWEVER CAUSED AND ON ANY THEORY OF LIABILITY, WHETHER IN CONTRACT, STRICT LIABILITY, OR TORT (INCLUDING NEGLIGENCE OR OTHERWISE) ARISING IN ANY WAY OUT OF THE USE OF THIS SOFTWARE, EVEN IF ADVISED OF THE POSSIBILITY OF SUCH DAMAGE.

(35) - ARM Ltd (arm and thumb variant targets only)

Copyright (c) 2009-2015 ARM Ltd
All rights reserved.

Redistribution and use in source and binary forms, with or without modification, are permitted provided that the following conditions are met:

1. Redistributions of source code must retain the above copyright notice, this list of conditions and the following disclaimer.
2. Redistributions in binary form must reproduce the above copyright notice, this list of conditions and the following disclaimer in the documentation and/or other materials provided with the distribution.
3. The name of the company may not be used to endorse or promote products derived from this software without specific prior written permission.

THIS SOFTWARE IS PROVIDED BY ARM LTD "AS IS" AND ANY EXPRESS OR IMPLIED WARRANTIES, INCLUDING, BUT NOT LIMITED TO, THE IMPLIED WARRANTIES OF MERCHANTABILITY AND FITNESS FOR A PARTICULAR PURPOSE ARE DISCLAIMED. IN NO EVENT SHALL ARM LTD BE LIABLE FOR ANY DIRECT, INDIRECT, INCIDENTAL, SPECIAL, EXEMPLARY, OR CONSEQUENTIAL DAMAGES (INCLUDING, BUT NOT LIMITED TO, PROCUREMENT OF SUBSTITUTE GOODS OR SERVICES; LOSS OF USE, DATA, OR PROFITS; OR BUSINESS INTERRUPTION) HOWEVER CAUSED AND ON ANY THEORY OF LIABILITY, WHETHER IN CONTRACT, STRICT LIABILITY, OR TORT (INCLUDING NEGLIGENCE OR OTHERWISE) ARISING IN ANY WAY OUT OF THE USE OF THIS SOFTWARE, EVEN IF ADVISED OF THE POSSIBILITY OF SUCH DAMAGE.

(41) Ed Schouten - Free BSD

Copyright (c) 2008 Ed Schouten <ed@FreeBSD.org>
All rights reserved.

Redistribution and use in source and binary forms, with or without modification, are permitted provided that the following conditions are met:

1. Redistributions of source code must retain the above copyright notice, this list of conditions and the following disclaimer.
2. Redistributions in binary form must reproduce the above copyright notice, this list of conditions and the following disclaimer in the documentation and/or other materials provided with the distribution.

THIS SOFTWARE IS PROVIDED BY THE AUTHOR AND CONTRIBUTORS "AS IS" AND ANY EXPRESS OR IMPLIED WARRANTIES, INCLUDING, BUT NOT LIMITED TO, THE IMPLIED WARRANTIES OF MERCHANTABILITY AND FITNESS FOR A PARTICULAR PURPOSE ARE DISCLAIMED. IN NO EVENT SHALL THE AUTHOR OR CONTRIBUTORS BE LIABLE FOR ANY DIRECT, INDIRECT, INCIDENTAL, SPECIAL, EXEMPLARY, OR CONSEQUENTIAL DAMAGES (INCLUDING, BUT NOT LIMITED TO, PROCUREMENT OF SUBSTITUTE GOODS OR SERVICES; LOSS OF USE, DATA, OR PROFITS; OR BUSINESS INTERRUPTION) HOWEVER CAUSED AND ON ANY THEORY OF LIABILITY, WHETHER IN CONTRACT, STRICT LIABILITY, OR TORT (INCLUDING NEGLIGENCE OR OTHERWISE) ARISING IN ANY WAY OUT OF THE USE OF THIS SOFTWARE, EVEN IF ADVISED OF THE POSSIBILITY OF SUCH DAMAGE.

easy-ecc

Copyright (c) 2013, Kenneth MacKay
All rights reserved.

Redistribution and use in source and binary forms, with or without modification, are permitted provided that the following conditions are met:

- * Redistributions of source code must retain the above copyright notice, this list of conditions and the following disclaimer.
- * Redistributions in binary form must reproduce the above copyright notice this list of conditions and the following disclaimer in the documentation and/or other materials provided with the distribution.

THIS SOFTWARE IS PROVIDED BY THE COPYRIGHT HOLDERS AND CONTRIBUTORS "AS IS" AND ANY EXPRESS OR IMPLIED WARRANTIES, INCLUDING, BUT NOT LIMITED TO, THE IMPLIED WARRANTIES OF MERCHANTABILITY AND FITNESS FOR A PARTICULAR PURPOSE ARE DISCLAIMED. IN NO EVENT SHALL THE COPYRIGHT HOLDER OR CONTRIBUTORS BE LIABLE FOR ANY DIRECT, INDIRECT, INCIDENTAL, SPECIAL, EXEMPLARY, OR CONSEQUENTIAL DAMAGES (INCLUDING, BUT NOT LIMITED TO, PROCUREMENT OF SUBSTITUTE GOODS OR SERVICES; LOSS OF USE, DATA, OR PROFITS; OR BUSINESS INTERRUPTION) HOWEVER CAUSED AND ON ANY THEORY OF LIABILITY, WHETHER IN CONTRACT, STRICT LIABILITY, OR TORT (INCLUDING NEGLIGENCE OR OTHERWISE) ARISING IN ANY WAY OUT OF THE USE OF THIS SOFTWARE, EVEN IF ADVISED OF THE POSSIBILITY OF SUCH DAMAGE.

Disposal of Old Equipment

Only for European Union and countries with recycling systems



This symbol on the products, packaging, and/or accompanying documents means that used electrical and electronic products must not be mixed with general household waste.

For proper treatment, recovery and recycling of old products, please take them to applicable collection points in accordance with your national legislation.

By disposing of them correctly, you will help to save valuable resources and prevent any potential negative effects on human health and the environment. For more information about collection and recycling, please contact your local municipality.

Penalties may be applicable for incorrect disposal of this waste, in accordance with national legislation.

Specifications

Input Voltage	DC12 V (supplied from the T10 connector of the indoor unit)
Power consumption	Max: 2.4 W
Size	(H) 120 mm × (W) 70 mm × (D) 25 mm
Weight	190 g (including communication lines)
Interface	Wireless LAN
Wireless standard	IEEE 802.11 b/g/n
Frequency range	2.4 GHz band
Encryption	WPA™ / WPA2™ / WPA3™
Temperature/ Humidity range	0 °C to 55 °C / 20 % to 80 % (no condensation) *Indoor use only

Setting Information

WLAN Adaptor serial number (ID)	
Indoor unit model name	
Indoor unit serial number	
Outdoor unit model name	
Outdoor unit serial number	
System commissioning date	
WLAN Adaptor installation date	

Installer Contact Details

Name	
Telephone number	

Maximum radio-frequency power transmitted in the frequency bands

Type of wireless	Frequency band	Max EIRP (dBm)
WLAN	2412-2472 MHz	20 dBm

 Authorized representative in EU
Panasonic Testing Centre
Panasonic Marketing Europe GmbH
Winsbergring 15, 22525 Hamburg, Germany

 Contact in the UK
Panasonic UK, a branch of Panasonic
Marketing Europe GmbH, Maxis 2, Western
Road, Bracknell, Berkshire, RG12 1RT

Panasonic Corporation

<http://www.panasonic.com>

© Panasonic Corporation 2024

WEB-ACXF60-55220-EN

T0524-0